





STALMOT GROUP





NOWOŚCI :: NOVELTIES :: NEUHEITEN ::
НОВИНКИ :: NUEVO :: NOUVEAUTES



6 - 73

aseptic line



74 - 77

UCHWYTY MEBLOWE :: FURNITURE HANDLES :: MÖBELGRIFFE ::
МЕБЕЛЬНЫЕ РУЧКИ :: TIRADORES DE MUEBLES :: POIGNÉES DE MEUBLES



78 - 153

GAŁKI :: KNOBS :: KNÖPFE ::
КНОПКИ :: POMOS :: POMMEAUX



154 - 185

WIESZAKI :: HANGERS :: HAKEN ::
КРЮЧКИ МЕБЕЛЬНЫЕ :: COLGADORES :: PATERES



186 - 201

KLUCZE, SZYLDY, ZAWIASY :: KEYS, BACKPLATES, HINGES ::
SCHLÜSSEL, SCHILDER, SCHARNIERE :: КЛЮЧИ, НАКЛАДКИ, ПЕТЛИ ::
LLAVES, PLACAS, BISAGRAS :: CLEFS, PLAQUES DE PROPRETÉ, CHARNIERES



202 - 207

NÓŻKI :: LEGS :: FÜßE ::
НОЖКИ МЕБЕЛЬНЫЕ :: PATAS :: PIEDS

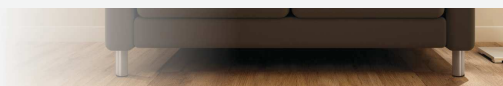

208 - 219

INNE :: OTHER ACCESSORIES :: SONSTIGE ::
ДРУГИЕ :: OTROS :: AUTRES

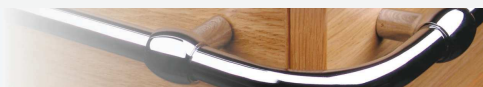

220 - 223

INFORMACJE :: INFORMATIONS :: INFORMATIONEN :: ИНФОРМАЦИЯ :: INFORMACIONES :: INFORMATIONS

INDEX :: INDEX :: INDEX ::
ИНДЕКС :: INDICE :: INDEX



224 - 227

WZORNIK :: SAMPLES OF COLOURS COATINGS :: OBERFLÄCHEN ::
ШАБЛОНЫ :: MUESTRARIO :: NUANCIER



228 - 231



Modular

s y s t e m

SYSTEM MODUŁOWY

GAMET S.A. to znaczący producent akcesoriów meblowych, dziś wizjoner wytyczający nową drogę w uchwytach modułowych. Jak zapewnić funkcjonalność mebli a jednocześnie dobrą i niezwykle uchwyt, dopasowujący się do stylu mebla, jego koloru i kształtu?

Odpowiedzią jest **MODULAR SYSTEM**

To propozycja firmy Gamet dla osób ceniących kreatywne podejście do projektowania mebli i aranżacji wnętrz. To system gdzie nie ma ograniczeń w kreowaniu własnego świata uchwytów. Różnorodność kształtów, kolorów i materiałów z których produkty tej serii są wykonane jest przeogromna. Nawet sposób zamontowania na meblu zależy wyłącznie od wyobraźni projektanta. Dodatkowym atutem produktów MODULAR SYSTEM firmy GAMET jest to, że wszystkie elementy są produkowane w Polsce.

Wykreuj swoją przyszłość z firmą GAMET!

MODULAR SYSTEM

GAMET S.A. is a major manufacturer of furniture accessories, nowadays leading company in creating a modular system handles. How to keep functionality of the furniture and select the unique handle matched with furniture style, color or shape?

The answer is **MODULAR SYSTEM**.

This is the offer for those who approach to furniture design and interior decoration. It's a system with no limits in a creation of your own world of cabinet handles. We offer the variety of shapes, colours and materials. Handles arrangement on the furniture is up to the imagination of a designer. Create your future with GAMET S.A.!

MODULAR SYSTEM

Gamet S.A. ist ein führender Hersteller von Möbelbeschlägen. Heute Visionär, der neue Wege mit den Modular-Möbelgriffen geht. Wie kann man die Funktionalität der Möbel beibehalten und gleichzeitig den ungewöhnlichen Griff den Möbeln und seiner Farbe und Form anpassen?

Die Antwort lautet: **MODULAR SYSTEM**.

Ein Angebot an Personen, die eine kreative Haltung zur Gestaltung ihrer Möbel und zur Einrichtung ihrer Wohnung schätzen. Dies ist ein System, das Ihrer Phantasie keine Grenzen setzt. Kreieren Sie Ihre Zukunft mit der Firma GAMET S.A.

MODULAR SYSTEM

GAMET S.A. - это крупнейший производитель мебельной фурнитуры, на сегодняшний день визионер, определяющий новые направления в дизайне модульных ручек. Как обеспечить функциональность мебели и одновременно подобрать необычную мебельную ручку, подходящую по стилю, цвету и форме готового изделия?

Ответом является **MODULAR SYSTEM**

Это предложение компании GAMET S.A. для тех, кто ценит креативный подход к проектированию мебели и дизайну интерьеров. Это система без ограничений в создании собственного мира мебельных ручек. Разнообразие форм, цветов и материалов, из которых сделаны ручки серии огромно. Даже способ монтажа зависит лишь от идеи дизайнера. Создай свое будущее с компанией GAMET S.A.!

SISTEMA MODULAR

GAMET S.A., un importante fabricante de los accesorios de muebles, hoy es un verdadero visionario que abre un nuevo camino en los Sistemas de Tiradores. ¿Cómo podemos garantizar la funcionalidad de los muebles y al mismo tiempo escoger un tirador especial, adaptado al estilo, color y forma del mobiliario?

La respuesta es el **SISTEMA MODULAR**.

Es la nueva propuesta de GAMET S.A. para las personas que valoran un enfoque creativo en el diseño de interiores y de mobiliario. Se trata de un sistema, en el que no existen limitaciones para crear todo un mundo nuevo de tiradores. La variedad de formas, colores y materiales, con los que cuentan los productos de esta serie, es inmensa. Incluso el modo de montaje en el mueble depende única y exclusivamente de la imaginación del diseñador.

¡Diseña tu futuro con GAMET S.A.!

MODULAR SYSTEM

MODULAR SYSTEM. GAMET S.A. est un fabricant d'accessoires de meubles important, aujourd'hui un visionnaire qui trace une nouvelle route dans les Poignées.

Comment garantir la fonctionnalité d'un meuble et en même temps choisir une poignée qui s'adapte au style du meuble, à sa couleur et forme.

C'est une proposition de GAMET S.A. pour les personnes qui apprécient la créativité dans la projection des meubles et dans l'arrangement des intérieurs. C'est un système où il n'y a pas de limites dans la création de son monde de propre monde des poignées. La diversité des formes, des couleurs et des matériaux desquelles les produits de cette série sont faits est énorme.

Même la façon de fixer la poignées sur le meuble dépend uniquement de l'imagination du créateur.

Crée ton futur avec GAMET S.A.!





GAMET®

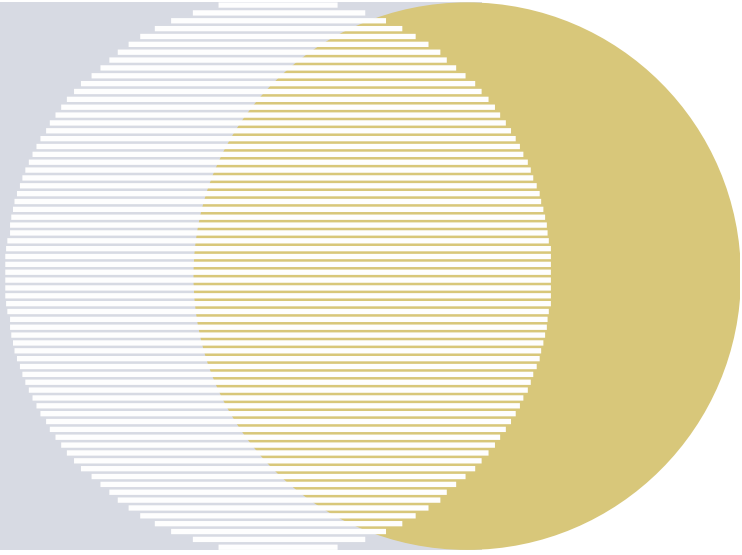



**NOWOŚCI
NOVELTIES
NEUHEITEN
НОВИНКИ
NUEVO
NOUVEAUTES**

BAROCCO

Designed by *Marcello Alini*
Gemmatopia

UR25 UR25-0128-GNE03-G0003
ZnAl



UR25 UR25-0128-G0035-G0003
ZnAl



UR25 UR25-0032-GPM25-G0018
ZnAl



UR25 UR25-0032-G0031-G0004
ZnAl



○ — ○ L - 32, 128 20

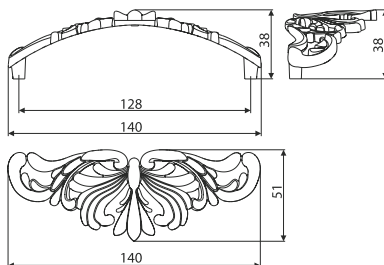
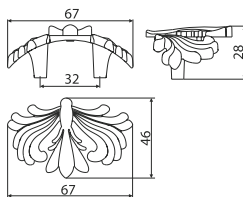

** Na specjalne zamówienie dostępne są inne wersje kolorystyczne :: Other colours available on request :: Andere Farboptionen sind auf individuelle Anfrage möglich. :: Разные цветовые варианты возможны по индивидуальному заказу :: Otros colores disponibles bajo pedido :: Les autres couleurs sont disponibles sur demande



ONDA

UR32 UR32-0128-G0005
ZnAl



GR32 GR32-G0005   177
ZnAl



UR32 UR32-0128-G0031
ZnAl



GR32 GR32-G0031   177
ZnAl



○ — L-128 50

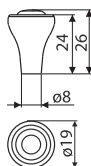
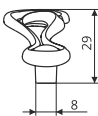
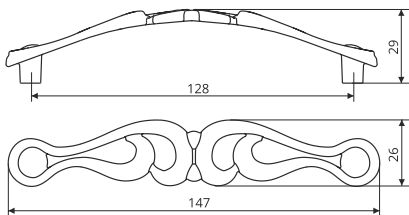



ONDA CRISTAL

made with Crystals from Swarovski®

UR32 UR32-0128-G0004-SW2
ZnAl



GR32 GR32-G0004-SW



UR32 UR32-0128-G0035-SW2
ZnAl



GR32 GR32-G0035-SW



○ → L-128 25

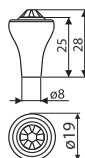
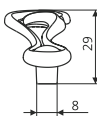
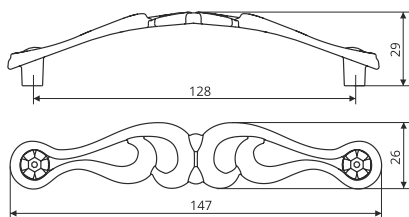



TRECCIA

Designed by *Marcello Aliperti*
Gemmatopia

UR46 UR46-0128-G0031
ZnAl



GR46 GR46-G0031



UR46 UR46-0128-G0035
ZnAl



GR46 GR46-G0035



○ → L-128 100

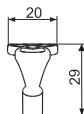
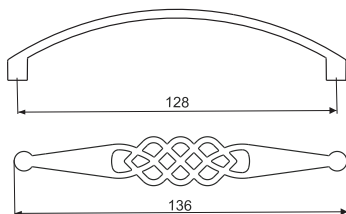



ANIMA

Designed by *Marcello Alini*
Gemmaroth

UR40 UR40-0128-G0035
ZnAl



UR40 UR40-0032-G0035
ZnAl



UR40 UR40-0128-G0031
ZnAl



UR40 UR40-0032-G0031
ZnAl



○ — L - 32, 128 50

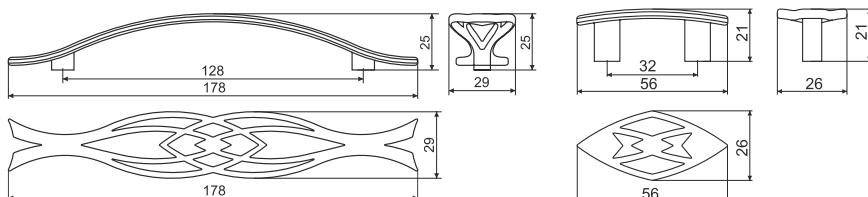



ANIMA CRISTAL

Designed by *Marcello Alconini*
Gemma Gioielli

made with Crystals from Swarovski®

UR40 UR40-0128-GNE03-SW
 ZnAl



UR40 UR40-0032-GNE03-SW
 ZnAl



UR40 UR40-0128-G0004-SW
 ZnAl



UR40 UR40-0032-G0004-SW
 ZnAl



○ — ○ L - 32, 128

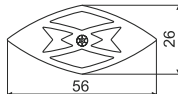
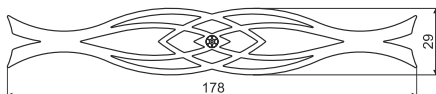
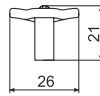
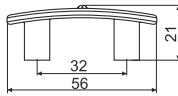
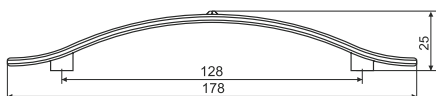



DIVINO

UR42 UR42-0128-G0031
ZnAl



UR42 UR42-0032-G0031
ZnAl



UR42 UR42-0128-G0035
ZnAl



UR42 UR42-0032-G0035
ZnAl



○ — ○ L - 32, 128 50

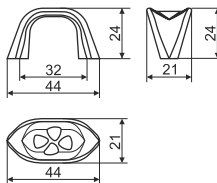
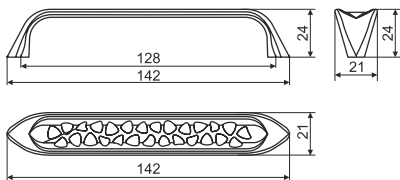



ANGELO

UR36 UR36-0128-G0031
ZnAl



GR36 GR36-G0031   174
ZnAl



UR36 UR36-0128-G0035
ZnAl



GR36 GR36-G0035   174
ZnAl



○ — ○ L - 128  50

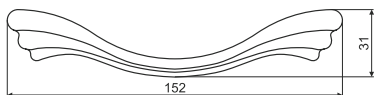
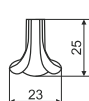
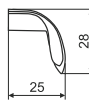
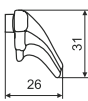
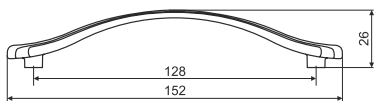



CLASSICO

UR41 UR41-0096-G0035
ZnAl



GR41 GR41-G0035   174
ZnAl



UR41 UR41-0128-G0031
ZnAl



○ → L-96, 128  50

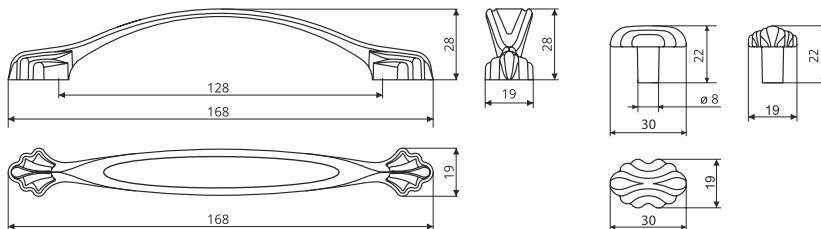



SERPENTE

UR43 UR43-0096-GA011
ZnAl



UR43 UR43-0128-GA011
ZnAl



UR43 UR43-0096-G0035
ZnAl



UR43 UR43-0128-G0035
ZnAl



○ — ○ L - 96, 128 100

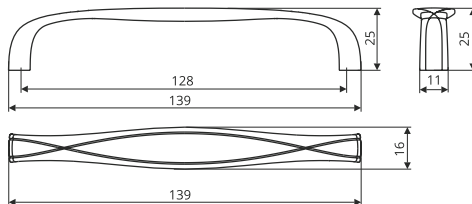



CORDA

UR44 UR44-0096-G0005
ZnAl



UR44 UR44-0128-G0005
ZnAl



UR44 UR44-0096-G0031
ZnAl



UR44 UR44-0128-G0031
ZnAl



○ — ○ L - 96, 128 100

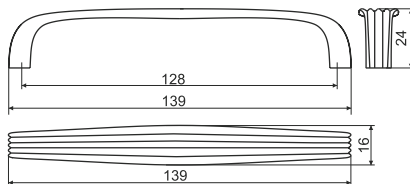



ZAMPA

UR45 UR45-0096-G0031
ZnAl



UR45 UR45-0128-G0006
ZnAl



UR45 UR45-0096-G0035
ZnAl



UR45 UR45-0128-G0008
ZnAl



○ — L - 96, 128
100

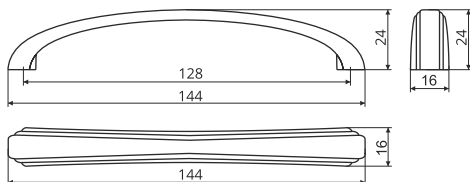



BOW

UN31 UN31-0128-G0007
ZnAl

UN31 UN31-0160-G0008
ZnAl



UN31 UN31-0192-G0035
ZnAl



○ — L - 128, 160, 192 50

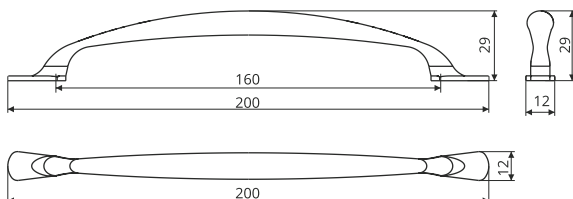



SHELL

UP11 UP11-0032-GAB02
ZnAl



UP11 UP11-0064-G0008
ZnAl



UP11 UP11-0096-G0007
ZnAl



UP11 UP11-0128-GAB02
ZnAl

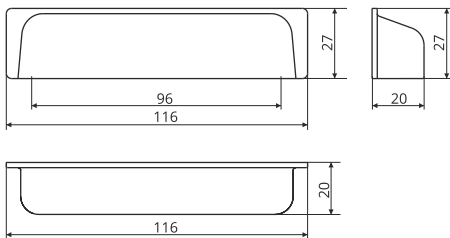



SCANDI

UP16 UP16-0128-G00AB-MLK-0

ZnAl
+Porcelana/ Porcelain/ Porzellan/Φαρфор/ Porcelana/ Porcelaine



UP16 UP16-0128-GA011-WHT-0

ZnAl
+Porcelana/ Porcelain/ Porzellan/Φαρфор/ Porcelana/ Porcelaine

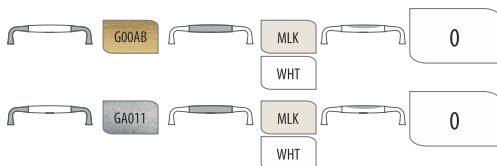
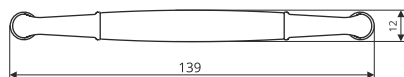
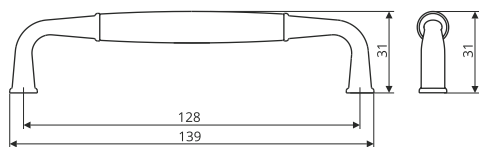



BELLO

GP19 GP19-G00AB-MLK-17   182

ZnAl
+Porcelana/ Porcelain/ Porzellan/Фарфор/ Porcelana/ Porcelaine



UP17 UP17-0096-G00AB-MLK-17

ZnAl
+Porcelana/ Porcelain/ Porzellan/Фарфор/ Porcelana/ Porcelaine



UP17 UP17-0128-GA011-WHT-16









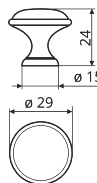
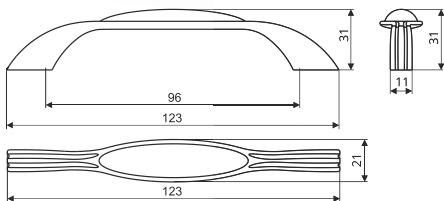



ZnAl
+Porcelana/ Porcelain/ Porzellan/Фарфор/ Porcelana/ Porcelaine







GP19 GP19-GA011-WHT-16   182

ZnAl
+Porcelana/ Porcelain/ Porzellan/Фарфор/ Porcelana/ Porcelaine



	GA011		WHT		0	16	
	G00AB		WHT		0	16	
	G00AB		MLK		0	17	

 L - 96
 L - 128
 50
 25



HANTLE



UU15 UU15-0128-G0004-E40

ZnAl
+ Emalia/Enamel/Emaillefarben/Эмаль/Esmalte/Émail



UU15 UU15-0160-G0004-E50

ZnAl
+ Emalia/Enamel/Emaillefarben/Эмаль/Esmalte/Émail

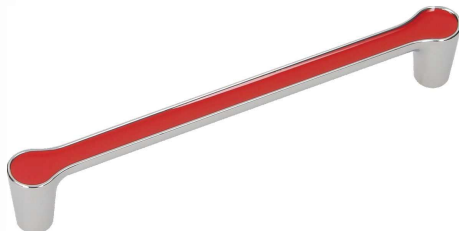

UU15 UU15-0320-G0004-E30

ZnAl
+ Emalia/Enamel/Emaillefarben/Эмаль/Esmalte/Émail



○ — ○ L - 128, 160, 192, 224, 320

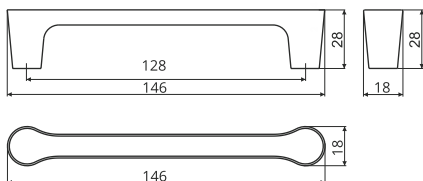



HANTLE



UU15 UU15-0128-RM030
ZnAl

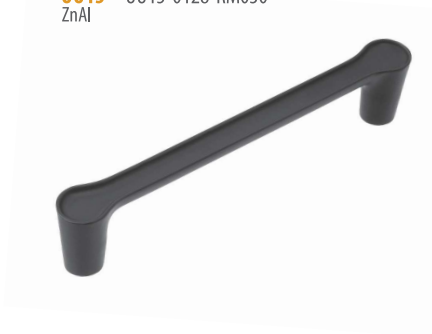

UU15 UU15-0160-G0008
ZnAl



UU15 UU15-0192-G0035
ZnAl



- — L - 128, 160 50
- — L - 192, 224, 320 25

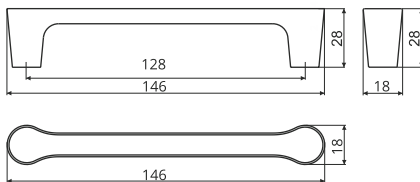



SIPARIO

GW23 GW23-G0007   170

ZnAl
+ Stal / Steel / Stahl / Cranh / Acero / Acier

RE23 RE23-0192-G0007

ZnAl
+ Stal / Steel / Stahl / Cranh / Acero / Acier



SIPARIO CRISTAL

made with Crystals from Swarovski®

RE23-...-SW RE23-0160-G0004-SW

ZnAl
+ Stal / Steel / Stahl / Cranh / Acero / Acier

GW23-...-SW GW23-G0004-SW   170

ZnAl
+ Stal / Steel / Stahl / Cranh / Acero / Acier

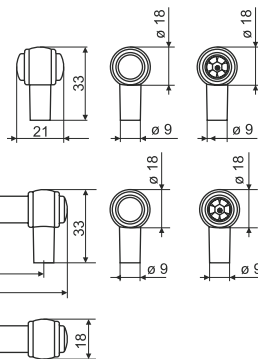

GW23, RE23

G0004

G0007

GW23-...-SW, RE23-...-SW

G0004*

○ — L - 96, 128

○ — L - 160, 192, 256, 320, 448, 480

 50
 20

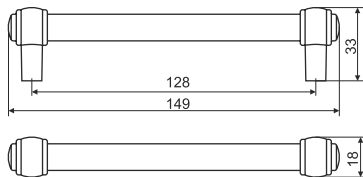

Na specjalne zamówienie możliwość wykonania innych długości relingów w kolorze G0004 i G0007. Maksymalna długość całkowita produktu 1000 mm.
Other lengths of T-bar handles in colour G0004 and G0007 on request. Maximum total length 1000 mm.

Auf individuelle Anfragen besteht die Möglichkeit, andere Längen der Rellingriffe in G0004 und G0007 zu liefern. Maximale Gesamtlänge des Produktes 1000 mm.

Возможны нестандартные размеры реylingов в цвете G0004 и G0007. Максимальная полная длина продукта - 1000 мм.

A petición del cliente se pueden fabricar diferentes longitudes de las barandillas. Colores G0004 y G0007. Longitud máxima del producto - 1000 mm.

Il y a la possibilité de réaliser sur la demande spéciale de différents longueurs de relings en finition G0007 et G0004. La longueur maximum d'un produit 1000mm.



SIPARIO SYSTEM

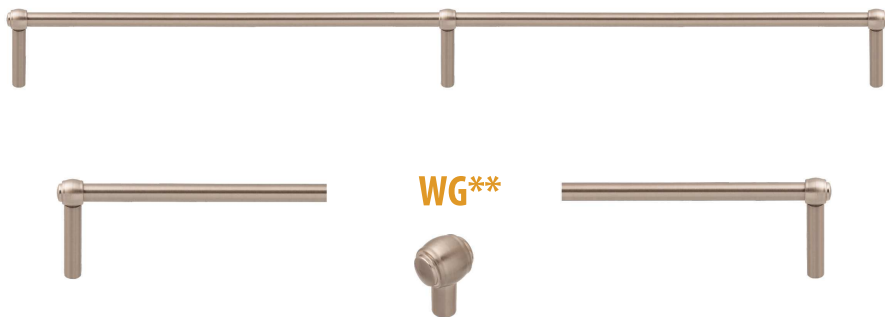

W skład systemu przedpokojowego WG wchodzi: / The WG system consist of: / Zum System des Garderoben-Sets gehören: / В состав системы WG входят: / El sistema vestíbulo WG incluye: / Le système d'anti-chambre WG se compose de:

2 relingi boczne / 2 side bars / 2 Seitenrelinge / 2 боковые рейлинга / 2 barandillas laterales / 2 relings latéraux

1 reling przedni / 1 front bar / 1 Vorderreling / 1 передний рейлинг / 1 barandilla frontal / 1 reling d'avant

8 gafek GW23 / 8 knobs GW23 / 8 Knöpfe GW23 / 8 кнопок-крючков GW23 / 8 pomos GW23 / 8 boutons GW23

10 wkrętów 1-WKR-M4X22-P / 10 screw 1-WKR-M4X22-P / 10 Schrauben M4x22 / 10 винтов 1-WKR-M4X22-P / 10 tornillos 1-WKR-M4X22-P / 10 vis 1-WKR-M4X22-P

5 wkrętów 1-WKR-M4X65-P / 5 screws 1-WKR-M4X65-P / 5 Schrauben M4x65 / 5 винтов 1-WKR-M4X65-P / 5 tornillos 1-WKR-M4X65-P / 5 vis 1-WKR-M4X65-P



** Możliwość innych wymiarów pod indywidualne zamówienie klienta :: Other dimensions on request :: Auf individuelle Anfrage des Kunden besteht die Möglichkeit, andere Abmessungen zu liefern. :: Существует возможность других размеров под индивидуальный заказ клиента :: Posibilidad de otras dimensiones bajo petición del cliente :: Il y a la possibilité de changer des dimensions sur commande individuelle du client

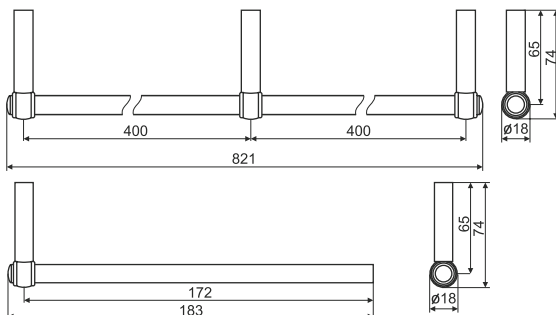



HILL

UU16 UU16-0128-G0004
ZnAl



UU16 UU16-0160-G0008
ZnAl



UU16 UU16-0320-G0007
ZnAl



G0004 G0006 G0007 G0008

○ — L - 128, 160, 192 50
○ — L - 320 25

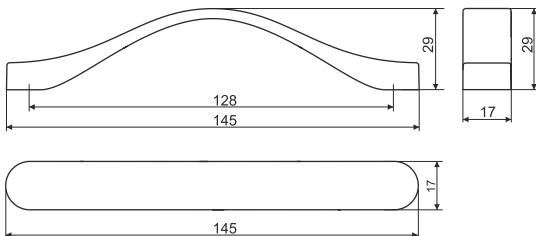



PONTE

UU03 UU03-0128-RM030
ZnAl



UU03 UU03-0160-G0007
ZnAl



UU03 UU03-0320-G0008
ZnAl



○ — L - 128, 160
○ — L - 320



50
25

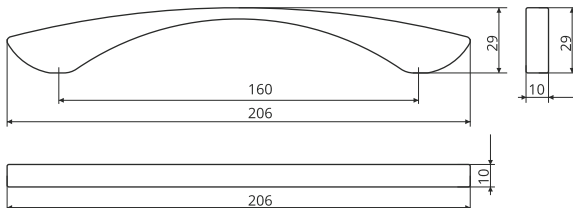



NASTRO

UU13 UU13-0128-G0004
ZnAl



UU13 UU13-0128-G0006
ZnAl



UU13 UU13-0160-G0007
ZnAl



○ — L - 128, 160 50

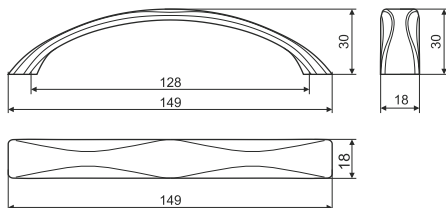



ARCADA

UA91 UA91-0128-G0004
Al



UA91 UA91-0032-G0004
Al



UA91 UA91-0032-G0006
Al



UA91 UA91-0160-G0004
Al



○ → L-32, 128, 160

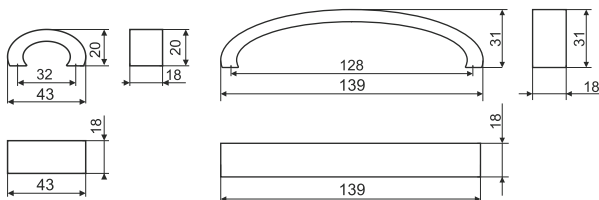



ORGANIC

UU05 UU05-0128-G0004
ZnAl



UU05 UU05-0160-R0030
ZnAl



UU05 UU05-0320-G0007
ZnAl



○ — L - 128, 160, 320

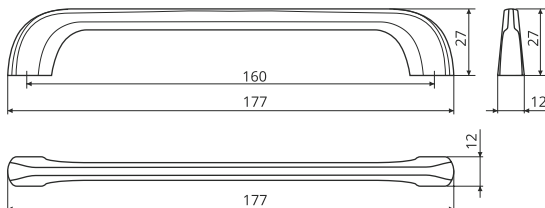



RAGGIO

UA76 UA76-0160-G0004-0210-2

Al



UA77 UA77-0320-G0004-0369-2

Al



UA78 UA78-416-G0004-0465-2

Al



UA82 UA82-0416-0480-G0004-0560-4

Al

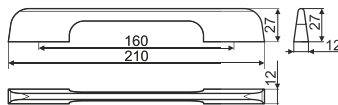
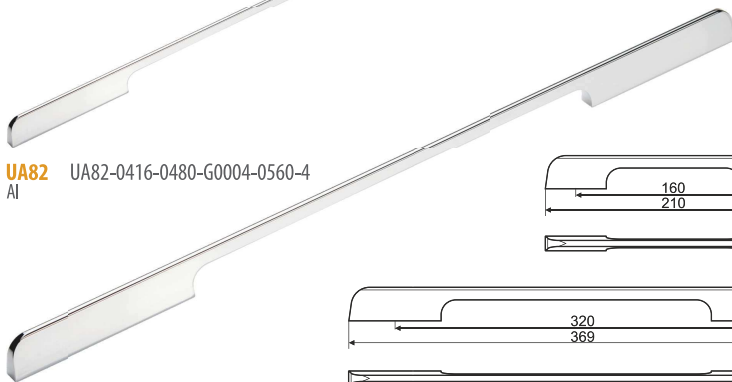

UA76

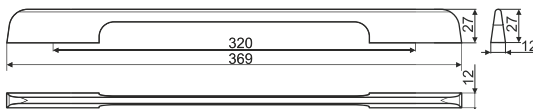

UA77

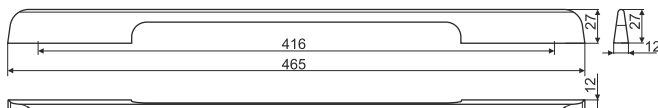

UA78

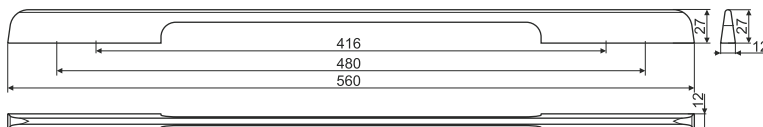

UA82

G0004

A0C00



10

Możliwe rozwiązania niestandardowe na indywidualne zamówienie Klienta. :: Non-standard sizes available on request. :: Vom Standard abweichende Bohrstände sind auf individuelle Anfrage möglich. :: Возможны нестандартные размеры по индивидуальному заказу :: Posibilidad de realizar medidas personalizadas bajo petición del cliente. :: Les entraxes non-standard possibles sur demandé un client.

Zakaz sprzedaży modeli na terenie Polski. :: Sale in Poland is prohibited. :: Das Produkt ist nicht für den polnischen Markt zugelassen. :: Продукт не продается на территории Польши. :: Venta de los modelos está prohibida en el mercado polaco. :: La vente des modèles est interdite en Pologne.



STRADA

RE28 RE28-0160-G0004
ZnAl+Al



RE28 RE28-0320-G0004
ZnAl+Al



- — ○ L - 128, 160, 192
- — ○ L - 256, 320, 416

 20
10

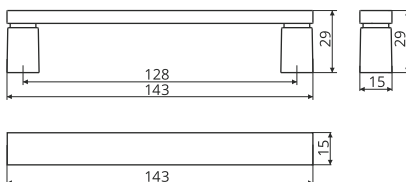



LOGIC

UA59 UA59-0160-A0C00

Al



UA59 UA59-0320-R0030-2

Al



- — L - 128, 160, 192 25
- — L - 320 10





WA09

WA09 WA09-0032-G0004-0320
Al



WA09 WA09-0064-G0004-0400
Al



G0004

○ — ○ L-32, 64 10 

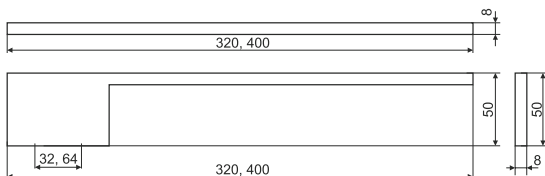



GANCHO

US12 US12-0064-RM030

Stal / Steel / Stahl /
Сталь / Acero / Acier



US12 US12-0064-G0008

Stal / Steel / Stahl /
Сталь / Acero / Acier

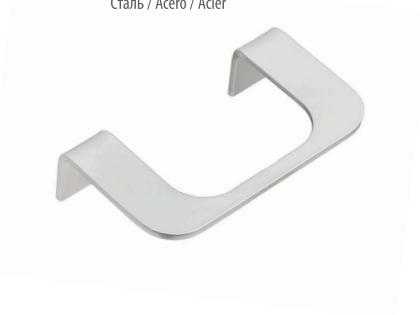

US12 US12-0064-R0026

Stal / Steel / Stahl /
Сталь / Acero / Acier



US12 US12-0064-R0027

Stal / Steel / Stahl /
Сталь / Acero / Acier

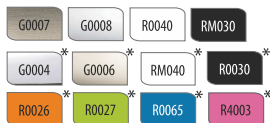

○ — ○ L - 64 50

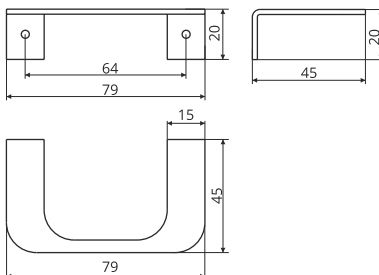



UA92

UA92 UA92-0346-G0004-19
Al



UA92 UA92-0346-G0007-19
Al

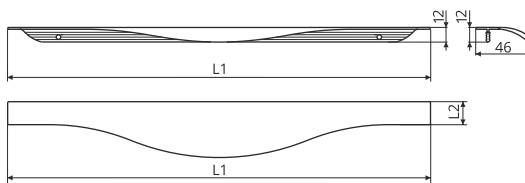

L1 (mm)	346	396	446	496	596	796	346	396	446	496	596	796
L2 (mm)	19	19	19	19	19	19	21	21	21	21	21	21



PA-UA

PA-UA93

Al



PA-UA94

Al



PA-UA96

Al



PA-UA93

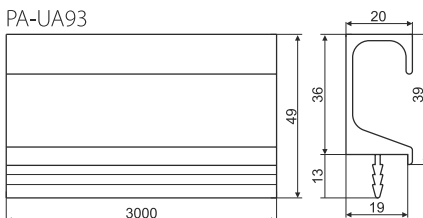

PA-UA94

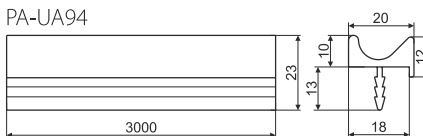

PA-UA96

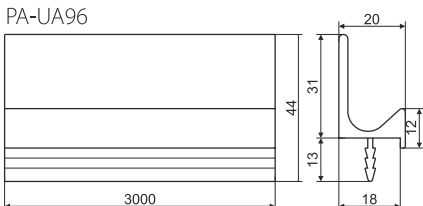

AOC00

L - 3000



10



**NOWE POKRYCIA GALWANICZNE :: NEW GALVANIC COATINGS ::
 NEUE GALVANISCHE OBERFLÄCHEN :: НОВЫЕ ГАЛЬВАНИЧЕСКИЕ ПОКРЫТИЯ ::
 NUEVOS ACABADOS GALVÁNICOS :: NOUVELLES FINITIONS GALVANIQUES**

Miedź szczotkowana :: Brushed copper :: Kupfer gebürstet :: Крацованная медь :: cobre cepillado :: Cuivre brossé

GR41 GR41-GE018
ZnAl



UR41 UR41-0128-GE018
ZnAl



Półmatowa patyna na miedzi :: Semi matt patinated copper :: Patina halbmatt auf Kupfer :: Патинованная полуматовая медь ::
 Mate semi patinado cobre :: Patine semi-matte sur cuivre

GR41 GR41-GPM25
ZnAl



UR41 UR41-0128-GPM25
ZnAl







aseptic line

Oferta dedykowana zarówno klientom indywidualnym jak i instytucjom takich jak szpitale, przychodnie, apteki, centra spa, przedszkola i żłobki.

The offer is customised both to individual customers and institutions such as hospitals, clinics, pharmacies, spa centers, kindergartens and nurseries. Wherever hygiene is most important.

Angebot richtet sich sowohl an individuelle als auch an institutionelle Kunden, wie Krankenhäuser, Kliniken, Apotheken, SPA, Kindergärten und Krippen. Überall, wo Hygiene das Wichtigste ist.

Предложение предназначено как для индивидуальных клиентов, так и для учреждений таких как больницы, клиники, аптеки, спа, детские сады, ясли. Везде, где гигиена имеет первостепенное значение.

La oferta está destinada tanto a los clientes particulares, como a los institucionales: hospitales, consultorios médicos, farmacia, centros spa, guarderías y jardines de infancia.

L'offre destinée aussi bien aux clients individuels qu'aux clients d'institutions comme hôpitaux, cliniques, pharmacies, centres de SPAa, écoles maternelles et crèches

Innowacyjna powłoka ASEPTIC LINE zapewnia ochronę przed bakteriami, minimalizuje ryzyko wystąpienia alergii na nikiel i chrom.

Innovative ASEPTIC LINE colour: provides protection against bacteria, minimizes the risk of contact allergy to nickel and chrome.

Die innovative Oberfläche ASEPTIC LINE schützt vor Bakterien, minimalisiert das Risiko von Kontaktallergien gegen Nickel und Chrom.

Иновационное гальваническое покрытие ASEPTIC LINE: обеспечивает защиту от бактерий, минимализирует риск появления аллергических реакций на никель и хром.

El innovador revestimiento ASEPTIC LINE proporciona protección contra bacterias, reduce al mínimo el riesgo de aparición de alergias al níquel y al cromo.

Le revêtement ASEPTIC LINE garantit une protection contre les bactéries, minimise le risque d'allergies au nickel et au chrome.

Pozytywne wyniki badań ASEPTIC LINE.

ASEPTIC LINE positive test results.

Positive Forschungsergebnisse für ASEPTIC LINE.

Позитивные результаты исследований ASEPTIC LINE.

Los resultados positivos de pruebas de ASEPTIC LINE.

Les résultats positifs aux tests obtenus par ASEPTIC LINE.

Właściwości antybakteryjne potwierdzone badaniami w niezależnych laboratoriach w Polsce i USA.

Antimicrobial properties confirmed by tests in independent laboratories in Poland and the USA.

Antibakteriellen Eigenschaften wurden durch Untersuchungen in unabhängigen Laboren in Polen und den Vereinigten Staaten bestätigt.

Антибактериальные свойства подтверждены исследованиями независимых лабораторий в Польше и США.

Las propiedades antibacterianas demostradas en los ensayos realizados en los laboratorios independientes en Polonia y en los EE.UU.

Les qualités bactericides certifiées par les expertises dans des laboratoires indépendents en Pologne et aux États-Unis.

Brak niklu i chromu w powłoce potwierdzony badaniem wykonanym przez Wydział Chemii Uniwersytetu Mikołaja Kopienika w Toruniu oraz przez instytut w Stanach Zjednoczonych.

Lack of nickel and chrome in the galvanic coating confirmed by examination made by Department of Chemistry, University of Nicolaus Copernicus in Toruń and by the institute in the USA.

Das Fehlen von Nickel und Chrom in der galvanischen Beschichtung wurde von den in der Chemiefakultät der Nicolaus Copernicus Universität in Torun und in dem Institut in den Vereinigten Staaten durchgeführten Untersuchungen bestätigt.

Отсутствие никеля и хрома в гальваническом покрытии было подтверждено исследованиями Химического факультета Университета Николая Коперника в Торуне (Польша) и независимого института в США.

La ausencia de níquel y de cromo en el revestimiento ha sido constatada mediante el examen realizado por la Facultad de Química de la Universidad Nicolás Copérnico de Toruń.

L'absence de nickel et de chrome dans le revêtement confirmée par une recherche effectuée par le Département de Chimie de l'Université de Nicolas Copernic à Toruń.

Działanie bakteriobójcze na szczepy bakterii Escherichia coli, Pseudomonas aeruginosa, Klebsiella pneumoniae i bakteriostatyczne Enterococcus faecalis potwierdzone badaniem sanitarnym wykonanym przez Powiatową Stację Sanitarno-Epidemiologiczną w Łodzi.

Antimicrobial properties of bacteria Escherichia coli, Pseudomonas aeruginosa, Klebsiella pneumoniae and bacteriostatic on Enterococcus faecalis confirmed by sanitary examination made by District Sanitary Station in Łódź and by institute in the USA.

Bakterientötende Wirkung gegen die Bakterienstämme Escherichia coli, Pseudomonas aeruginosa, Klebsiella pneumoniae sowie bakteriostatische Wirkung gegen Enterococcus faecalis wurde durch die von dem sanitärepidemiologischen Kreisinstitut in Łódź und von dem Institut in den Vereinigten Staaten durchgeführte sanitäre Untersuchung bestätigt.

Бактерицидное действие на штаммы бактерий Escherichia coli, Pseudomonas aeruginosa, Klebsiella pneumoniae и бактериостатическое на Enterococcus faecalis было подтверждено Районной санитарно-эпидемиологической станцией в Лодзи (Польша), а также независимым институтом в США.

La acción bactericida del revestimiento contra las cepas de bacterias Escherichia coli, Pseudomonas aeruginosa, Klebsiella pneumoniae y la acción bacteriostática contra la cepa Enterococcus faecalis han sido probadas mediante el examen sanitario realizado por el Centro de Vigilancia Sanitaria y Epidemiológica del distrito de Łódź.

L'action bactéricide sur les souches de bactéries Escherichia coli, Pseudomonas aeruginosa, Klebsiella pneumoniae et bactériostatique sur Enterococcus faecalis, confirmée par des recherches sanitaires effectuées par le Service communal de contrôle sanitaire et épidémiologique à Łódź.



NARVI
US91* US91-0128-WB00R
ZnAl

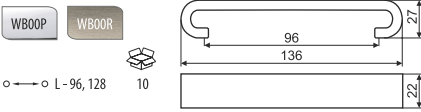

NARVI
GS91* GS91-WB00R
ZnAl



US10* US10-0064-WB00R
ZnAl

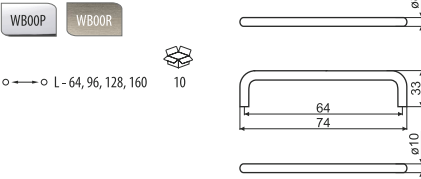

UN90* UN90-0128-WB00R
ZnAl

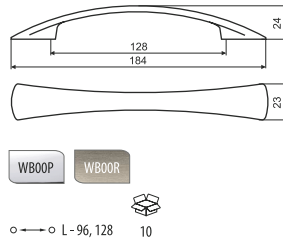

RE10* RE10-0256-WB00R-0356
ZnAl
+ Stal / Steel / Stahl / Сталь / Acero / Acier

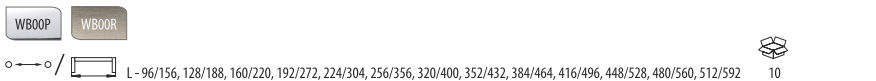

UN17* UN17-0128-WB00R
ZnAl

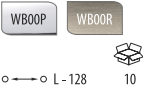
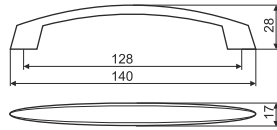

UZ94* UZ94-0128-WB00R
ZnAl

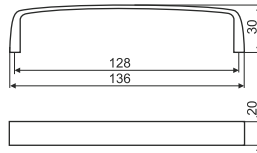

GA09* GA09-WB00R
ZnAl

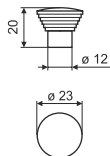

GG43* GG43-WB00R
ZnAl

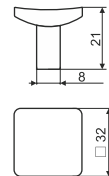



GAMET®





**UCHWYTY MEBLOWE
FURNITURE HANDLES
MÖBELGRIFFE
МЕБЕЛЬНЫЕ РУЧКИ
TIRADORES DE MUEBLES
POIGNÉES DE MEUBLES**

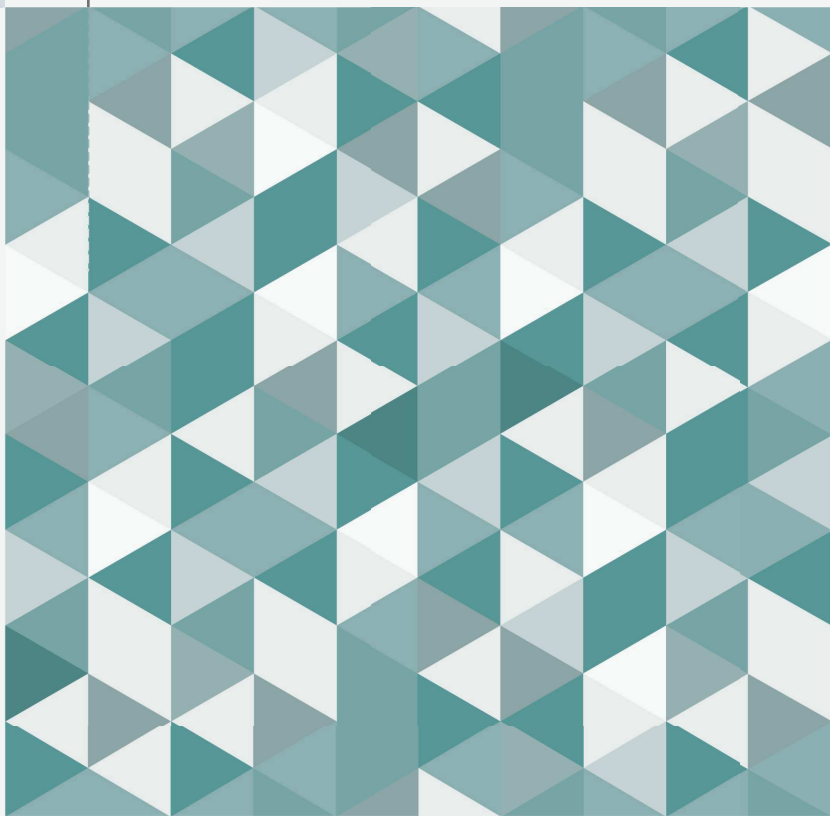

HANTLE

UU15 UU15-0128-G0004-E422

ZnAl
+ Emalia/Enamel/Emaillefarben/Эмаль/Esmalte/Émail



HANTLE

UU15 UU15-0192-G0004-E50

ZnAl
+ Emalia/Enamel/Emaillefarben/Эмаль/Esmalte/Émail



HANTLE

UU15 UU15-0320-G0004-E30

ZnAl
+ Emalia/Enamel/Emaillefarben/Эмаль/Esmalte/Émail



○ — ○ L - 128, 160, 192, 224, 320 25

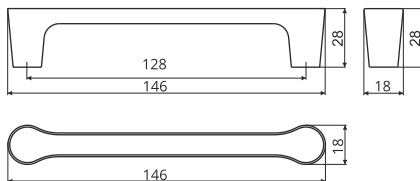



HANTLE
UU15 UU15-0160-RM030
ZnAl



HANTLE
UU15 UU15-0128-G0008
ZnAl



HANTLE
UU15 UU15-0192-G0035
ZnAl



- → L - 128, 160 50
 ○ → L - 192, 224, 320 25

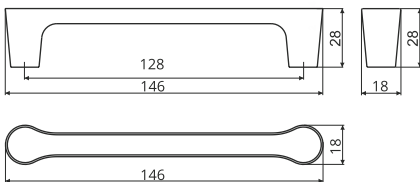

CAMELEON

UU06 UU06-0032-G0004-P43

ZnAl

+ Tworzywo / Plastic / Kunststoff /
Пластмасса / Plástico / Plastique



CAMELEON

UU06 UU06-0096-G0008-P42

ZnAl

+ Tworzywo / Plastic / Kunststoff /
Пластмасса / Plástico / Plastique

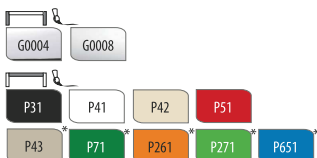
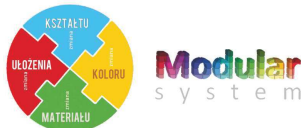

○ → L - 32 50
○ → L - 96 25

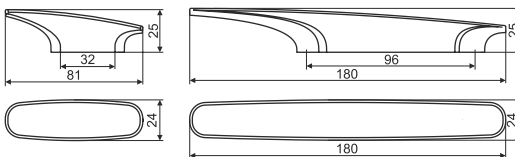

CAMELEON

UU07 UU07-0032-G0004-P42

ZnAl

+ Tworzywo / Plastic / Kunststoff /
Пластмасса / Plástico / Plastique



CAMELEON

UU07 UU07-0096-G0004-P43

ZnAl

+ Tworzywo / Plastic / Kunststoff /
Пластмасса / Plástico / Plastique

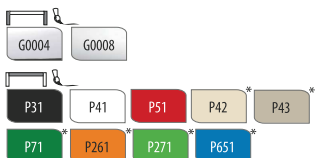

○ → L - 32 50
○ → L - 96 25

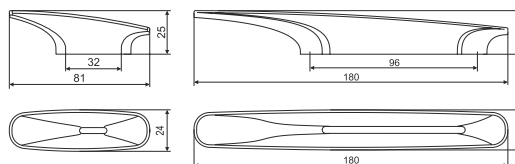

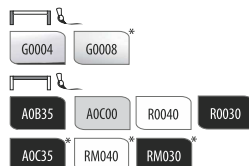
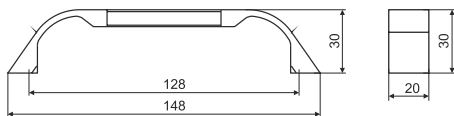

UA85 UA85-0128-R0030-G0008
ZnAl + Al

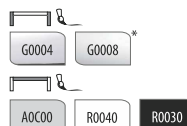

○ → ○ L-128  30
○ → ○ L-160, 192, 256, 320 15

UA67-...-ZN UA67-0160-R0030-G0004-ZN
ZnAl + Al



○ → ○ L-96, 128, 160, 192, 256, 320, 480, 587, 687, 800  50

UA67 UA67-0160-RSM08-R0030
ZnAl
+ Tworzywo / Plastic / Kunststoff /
Пластмасса / Plástico / Plastique

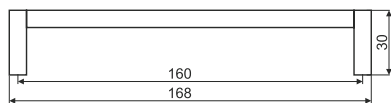

○ → ○ L-96, 128, 160, 192, 256  50

RU08 RU08-0192-G0004-A0C00
ZnAl + Al

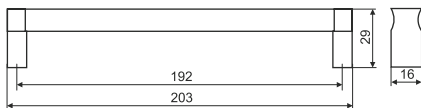

○ → L - 64, 96, 128, 160, 192, 224, 256, 287, 288, 320, 352, 384, 416, 480, 512, 544, 587, 687, 736



50

RU09 RU09-0160-G0004-A0C00
ZnAl + Al

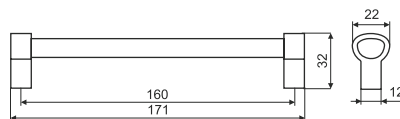

○ → L - 128, 160, 192



50

UA84 UA84-0160-A0C35-G0004
ZnAl + Al

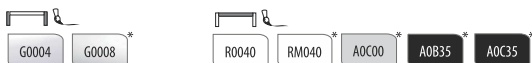
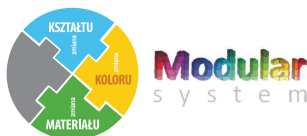
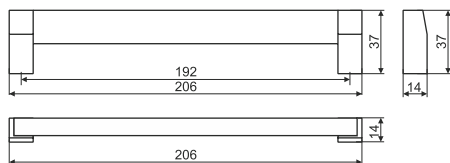

○ → L - 96 20
○ → L - 128, 160, 192, 256, 320 10



10

PUZZLE

UA66 UA66-0160-A0B35-G0004
ZnAl + Al

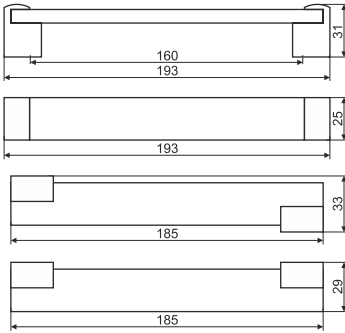

PUZZLE

GL66-1 GL66-1-A0B35-G0008
ZnAl + Al

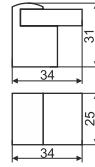

- → ○ L - 96, 128, 160, 192 10
- → ○ L - 480, 704 25
- → ○ L - 320 30

RITTO
US48

US48-0128-APB35-APB35
Al

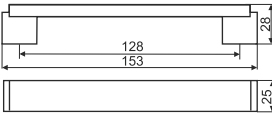

- → ○ L - 128, 160, 192, 256, 320, 448, 480, 512 10

RITTO
GS48

GS48-G0004-G0004
Al

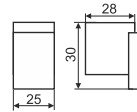

RITTO
WP48

WP48-APB35-APB35
Al

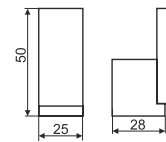

i 156

i 189

STRADA
RE28 RE28-0160-G0004
 ZnAl + Al

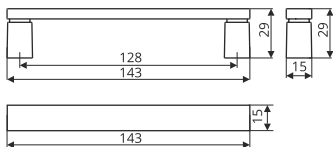
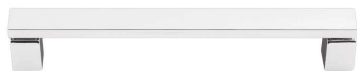

- — ○ L - 128, 160, 192 20
- — ○ L - 256, 320, 416 10

RE07 RE07-0160-A0C00-G0008
 ZnAl + Al

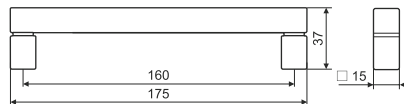

- — ○ L - 384 20
- — ○ L - 160, 320, 448, 544, 800 10

RE18 RE18-0160-G0007-SS
 ZnAl
 + Stal / Steel / Stahl / Сталь / Acero / Acier

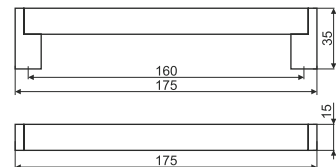

- — ○ L - 128, 160, 192, 256, 288 25
- — ○ L - 320, 448 10

RU05 RU05-0160-A0C00
 Al

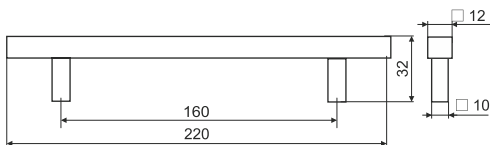

- — ○ L - 96, 128, 160, 192, 224, 256, 288, 320, 416, 480 50

RE50 RE50-0128-G0004-A0B35
ZnAl + Al

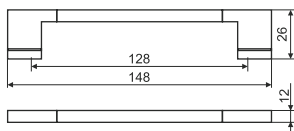

○ → ○ L - 96, 128, 160 25

UA55 UA55-0160-G0007
Al

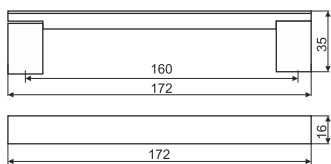

○ → ○ L - 128, 160, 192, 224, 256, 288, 320
352, 384, 416, 480, 560, 608 50

UN73 UN73-0192-G0006
ZnAl

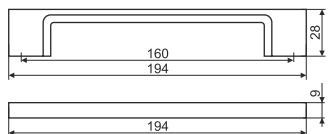

○ → ○ L - 96, 128, 160, 192 50
○ → ○ L - 256, 320 25

UA09 UA09-0128-A0C00
Al

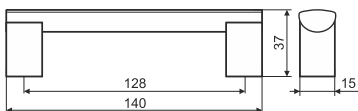

○ → ○ L - 96, 128, 160, 192 50
○ → ○ L - 224, 256, 288, 320, 352, 448, 480 25

RE21 RE21-0160-G0007
Stal / Steel / Stahl / Сталь / Accro / Acier

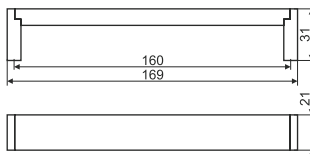

○ → ○ L - 128, 160, 192, 224, 256, 288 25
○ → ○ L - 320, 416, 448, 480 10



SLIM LINE

UN34 UN34-0128-G0007
ZnAl

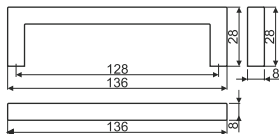

- — ○ L - 96, 128, 160, 192, 256, 480 50
- — ○ L - 320 25

UU67 UU67-0128-SS

Stal nierdzewna / Stainless steel / Edelstahl / Нержавеющая сталь / Acero inoxidable / Acier inoxydable

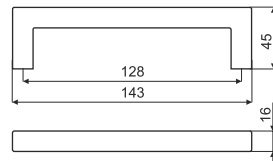

- — ○ L - 128, 160, 192, 320, 480 25

UU69 UU69-0128-SS-H30

Stal nierdzewna / Stainless steel / Edelstahl / Нержавеющая сталь / Acero inoxidable / Acier inoxydable

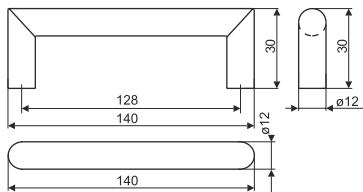

- — ○ L - 96, 128, 160, 192, 288, 320, 384, 480 25

UN71 UN71-0160-0192-G0007

ZnAl

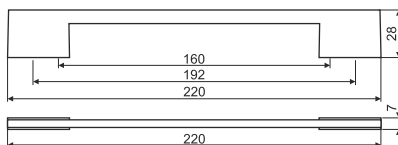

- — ○ / L - 96/128, 160/192 50
- L - 288/320 20

ORGANIC

UU05 UU05-0320-G0007
ZnAl



- — ○ L - 128, 160, 320 25

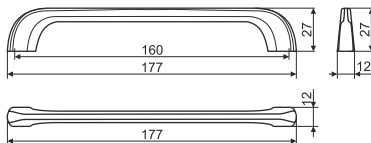



UA51 UA51-0128-A0C00
Al

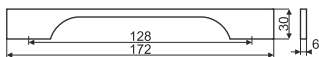

A0C00



- — L - 128, 160 20
- — L - 192, 224, 256, 288, 320 15

UA53 UA53-0256-A0C00
Al



A0C00



- — L - 192, 256 15

RAGGIO

UA76 UA76-0160-G0004-0210-2

Al



RAGGIO

UA77 UA77-0320-G0004-0369-2

Al



RAGGIO

UA78 UA78-416-G0004-0465-2

Al



RAGGIO

UA82 UA82-0416-0480-G0004-0560-4

Al

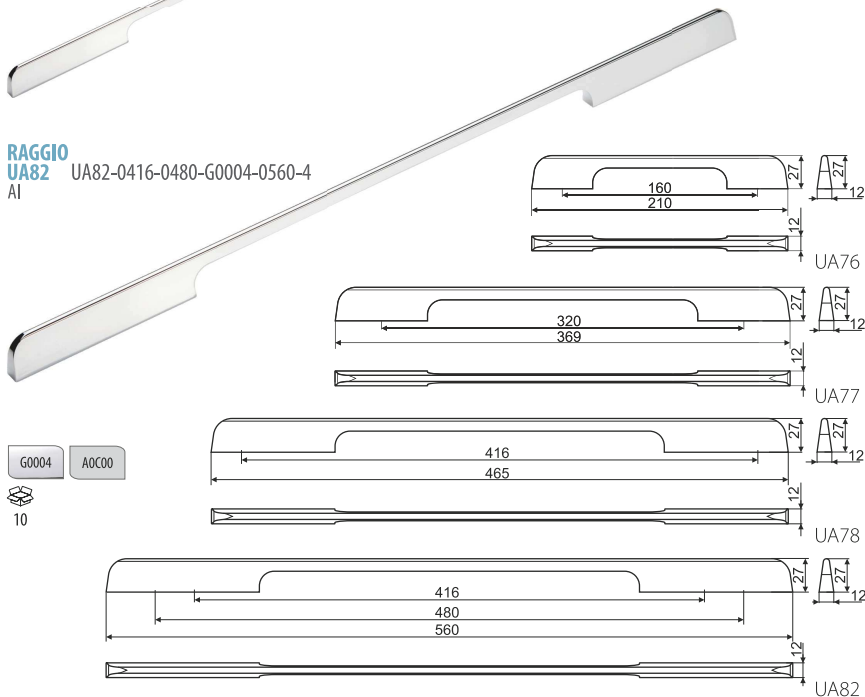

G0004

A0C00

10

Możliwe rozstawy niestandardowe na indywidualne zamówienie Klienta. :: Non-standard sizes available on request. :: Vom Standard abweichende Bohrstände sind auf individuelle Anfrage möglich. :: Возможны нестандартные размеры по индивидуальному заказу :: Posibilidad de realizar medidas personalizadas bajo petición del cliente. :: Les entraxes non-standard possibles sur demandé un client.

Zakaz sprzedaży modeli na terenie Polski. :: Sale in Poland is prohibited. :: Das Produkt ist nicht für den polnischen Markt zugelassen. :: Продукт не продается на территории Польши. :: Venta de los modelos está prohibida en el mercado polaco. :: La vente des modèles est interdite en Pologne.

MODERNO

UA48 UA48-0128-A0C00-G0008

Al
+ Stal / Steel / Stahl / Сталь / Acero / Acier

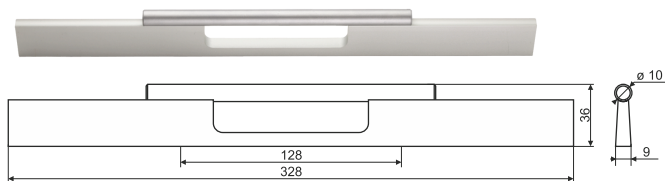

L - 128/328, 160/360, 192/392 10



MODERNO

UA46 UA46-0128-A0C00-G0004

Al
+ Stal / Steel / Stahl / Сталь / Acero / Acier

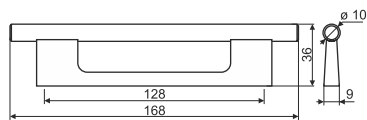

L - 128/168, 160/200, 192/232 10

MODERNO

GL46 GL46-A0C00-G0004

Al
+ Stal / Steel / Stahl / Сталь / Acero / Acier

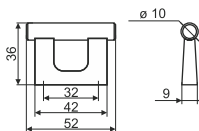

MODERNO

UA47 UA47-0128-A0C00-G0004

Al
+ Stal / Steel / Stahl / Сталь / Acero / Acier

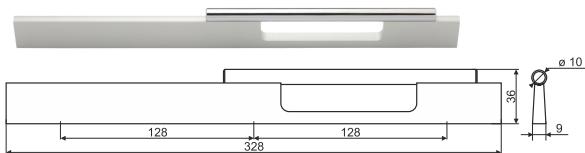

L - 128/328, 160/360, 192/392 10



MODERNO

WA45 WA45-A0C00-G0004

Al
+ Stal / Steel / Stahl / Сталь / Acero / Acier

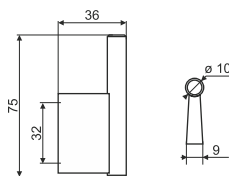

SIPARIO

RE23 RE23-0192-G0007

ZnAl
+ Stal / Steel / Stahl / Сталь / Acero / Acier

SIPARIO

GW23 GW23-G0007

ZnAl



- — L - 96, 128 50
- — L - 160, 192, 256, 320, 448, 480 20

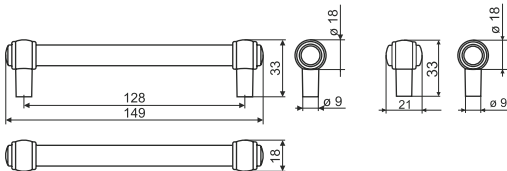

SIPARIO CRISTAL

RE23-....-SW RE23-0128-G0004-SW

ZnAl
+ Stal / Steel / Stahl / Сталь / Acero / Acier

SIPARIO CRISTAL

GW23-....-SW GW23-G0004-SW

ZnAl



made with Crystals from Swarovski®



- — L - 96, 128 50
- — L - 160, 192, 256, 320, 448, 480 20

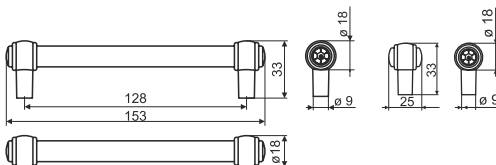

WK10 WK10-G0007

ZnAl



RE10-0160-G0007 + WK10-G0007

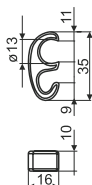

RE10 RE10-0192-G0006-0272

ZnAl

+ Stal / Steel / Stahl / Сталь / Acero / Acier



○ → ○ / L - 64/90, 96/156, 128/188, 160/220



50

○ → ○ / L - 192/272, 224/304, 256/356, 288/ 368, 320/ 400, 352/432

25

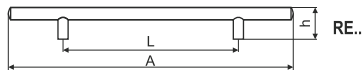

RE..

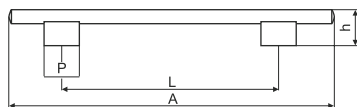

RE81 - P = 23 RE90 - P = 15

RE10, RE11, RE90

RE	L	A	RE	L	A
RE.../96	L=96	A=156	RE.../480	L=480	A=560
RE.../128	L=128	A=188	RE.../512	L=512	A=592
RE.../160	L=160	A=220	RE.../544	L=544	A=624
RE.../192	L=192	A=272	RE.../576	L=576	A=656
RE.../224	L=224	A=304	RE.../608	L=608	A=688
RE.../256	L=256	A=356	RE.../640	L=640	A=720
RE.../288	L=288	A=368	RE.../672	L=672	A=752
RE.../320	L=320	A=400	RE.../704	L=704	A=784
RE.../352	L=352	A=432	RE.../736	L=736	A=856
RE.../384	L=384	A=464	RE.../768	L=768	A=888
RE.../416	L=416	A=496	RE.../800	L=800	A=920
RE.../448	L=448	A=528			

RE11 RE11-0192-G0008-0272

Al

+ Stal / Steel / Stahl / Сталь / Acero / Acier

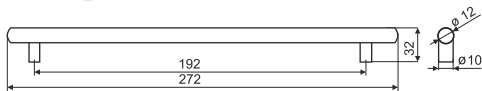

○ → ○ / L - 96/156, 128/188, 160/220



50

○ → ○ / L - 192/272, 256/356



20

RE 11. nóżka wkręcana

RE 11. screwed-in feet

RE 11. Fuß vormontiert

RE 11. ножка вкручиваемая

RE 11. pata atornillada

RE 11. pied a visser

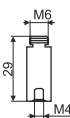

RE90* RE90-0192-G0007-0272

ZnAl

+ Stal / Steel / Stahl / Сталь / Acero / Acier

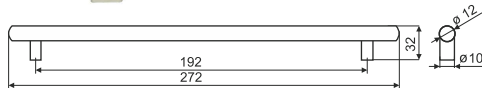

○ → ○ / L - 128/188, 160/220



50

○ → ○ / L - 192/272, 288/368, 480/560



20

UA06 UA06-0160-G0008-A0C00

ZnAl+Al

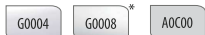
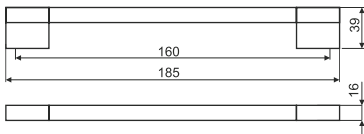

- → ○ L - 128, 160, 192, 224 50

RE81 RE81-0160-G0007

ZnAl

+ Stal / Steel / Stahl / Сталь / Acero / Acier

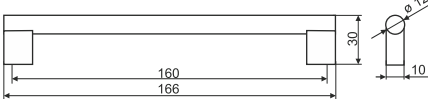

- → ○ L - 96, 128 50
- → ○ L - 160 25
- → ○ L - 192, 194, 224, 256, 277, 288, 320, 608 20

UU68* UU68-0288-G0008

Al

+ Stal / Steel / Stahl / Сталь / Acero / Acier

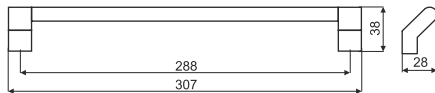

- → ○ L - 128, 288 25
- → ○ L - 480 10

RE82 RE82-0128-G0008-0148

Stal / Steel / Stahl / Сталь / Acero / Acier

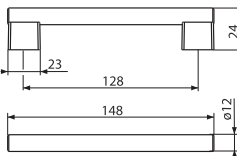

- → ○ / 25
- L - 128/148, 192/212 25
- L - 288/308 20

RE16 RE16-0160-G0007

ZnAl

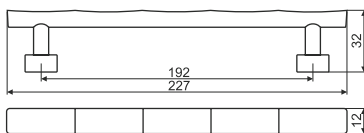

- → ○ L - 128, 160, 192, 320 25

DYNASTY

RU20

RU20-0128-G0004-A0C00

ZnAl

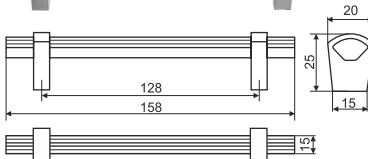

- → ○ L - 96, 128, 160 50

VERSA
UU30 UU30-0128-G0006
 ZnAl

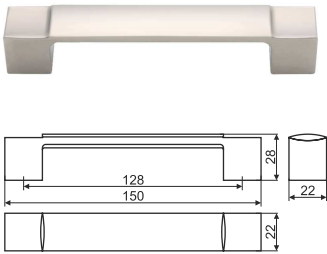

G0004 G0006 G0007 G0008

○ → L - 128, 160, 192, 224, 320, 480 25

VERSA
WP30 WP30-G0004   188
 ZnAl

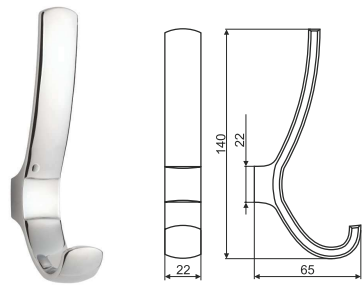

VERSA
GU30 GU30-G0004   156
 ZnAl

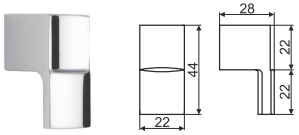

UU25 UU25-0160-G0008

ZnAl

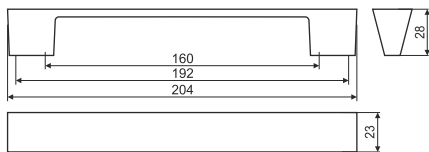

- → ○ L - 96 25
- → ○ L - 160 10
- → ○ L - 320, 480 25

UU04 UU04-0160-G0008

ZnAl

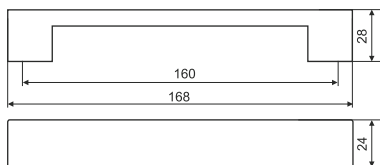

- → ○ L - 160 50

UZ25 UZ25-0160-G0006

ZnAl

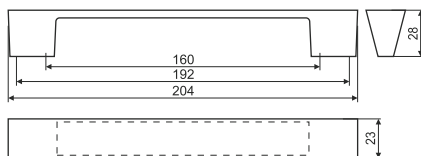

- → ○ L - 160 10

LOGIC

UA59 UA59-0128-A0C00-2

Al

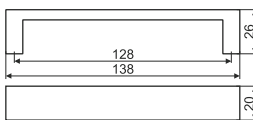

- → ○ L - 128, 160, 192 25
- → ○ L - 320 10

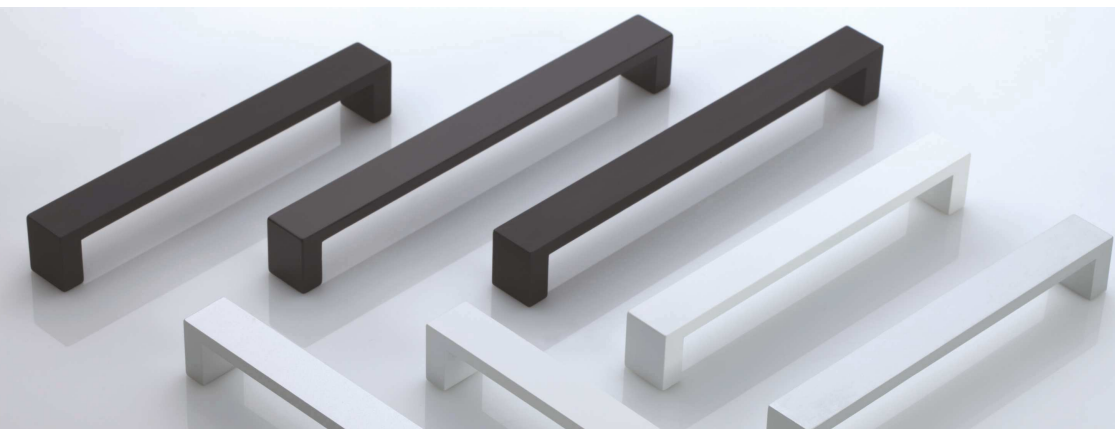

UNIVERSUM
UU24 UU24-0192-G0007
 ZnAl

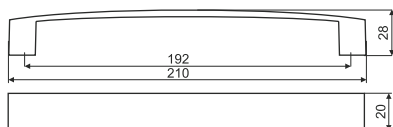

○ → ○ L - 128, 160, 192, 256, 320, 416 25

UNIVERSUM
GS24 GS24-G0006
 ZnAl

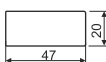

UA10 UA10-0128-A0C00
 Al

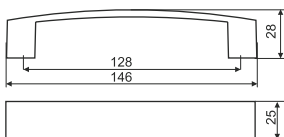

○ → ○ L - 128 25

UU27 UU27-0128-G0008
 ZnAl

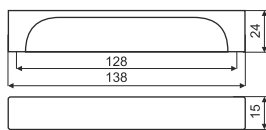

○ → ○ L - 128 20

POLARIS
US92 US92-0096-G0007
 ZnAl

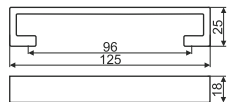

○ → ○ L - 96, 128 10

POLARIS
GS92 GS92-G0004
 ZnAl

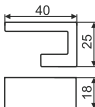

UG20 UG20-0096-G0008

ZnAl

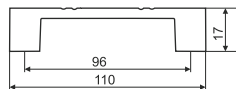

○ → ○ L - 64, 96 100

GG02 GG02-G006

ZnAl

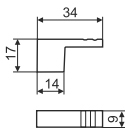

UN49 UN49-0128-G0007

ZnAl

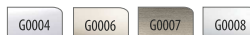
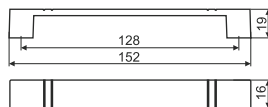

○ → ○ L - 128, 192 25

QUADRA

RG08 RG08-G0008

ZnAl

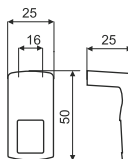

QUADRA

RR08 RR08-0160-G0004

ZnAl

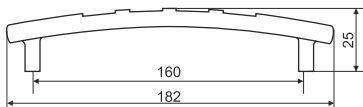

○ → ○ L - 96, 128 25
○ → ○ L - 160 20

QUADRA

RW08 RW08-G0007

ZnAl

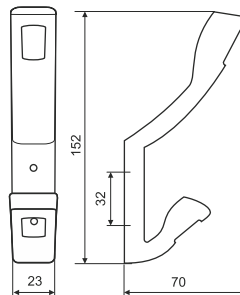

US21* US21-0096-G0006
ZnAl

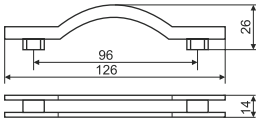

○ → ○ L-96 100

SPIRO
US15 US15-0128-G0004
ZnAl

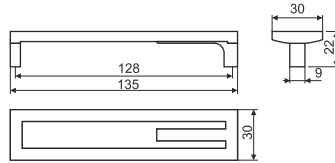
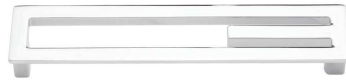

○ → ○ L-96, 128 50

SPIRO
WK15 WK15-0016-G0008
ZnAl

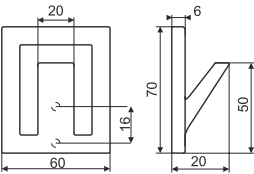

SPIRO
GS16 GS16-G0004
ZnAl

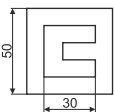
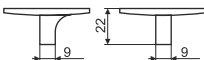

UG09 UG09-0128-G0004

ZnAl

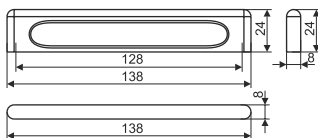

G0004



○ — ○ L - 128 25

UA12* UA12-0128-A0C00-2

Al

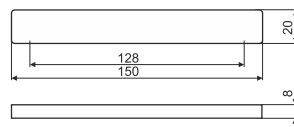

G0004 A0C00



○ — ○ L - 32, 128, 192 100
○ — ○ L - 320 25

UA02 UA02-0160-A0C00-2

Al

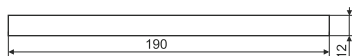
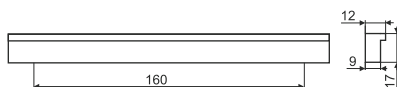

G0004 A0C00 AEC00 G0007*



○ — ○ L - 32, 64, 96, 128, 160, 192, 224, 256, 288, 320, 352, 370, 384, 480 100
○ — ○ L - 320, 576 50
○ — ○ L - 352 25

UA79 UA79-0128-G0004-0160-2-BP

Al

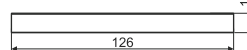
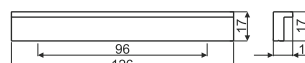

G0004 A0C00



○ — ○ / L - 32/62, 96/126, 128/160, 160/190 100
○ — ○ / L - 320/378, 370/400, 576/600 30

UA54 UA54-0096-A0C00-2

Al

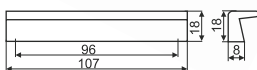

A0C00 G0004*



○ — ○ L - 96, 128, 160, 192 50

UA63 UA63-0096-A0C00-2

Al

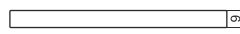
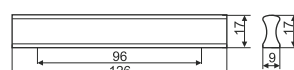

A0C00



○ — ○ L - 32, 96, 128, 160, 192, 224 100
○ — ○ L - 334 50

UA81 UA81-0128-G0004-0152-2-BP

AI

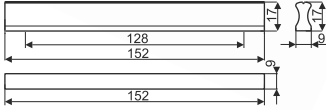

G0004

- — ○ / L - 128/152 50
- — ○ / L - 256/280, 352/376 20

UA15 UA15-0096-G0004-0124-2-BP

AI

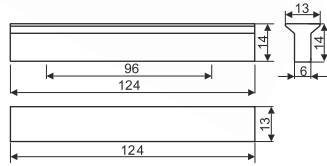

G0004

- — ○ / L - 96/124 100

UA89 UA89-0032-RM030

AI

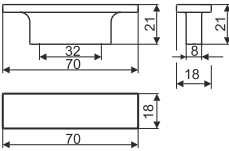

G0004

G0006

RM030

A0C00

- — ○ L - 32, 128 50



UU42* UU42-0032-G0007

ZnAl

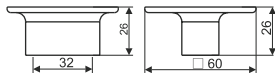

G0007



○ — ○ L - 32 25

UN26* UN26-0016-G0004-L

ZnAl

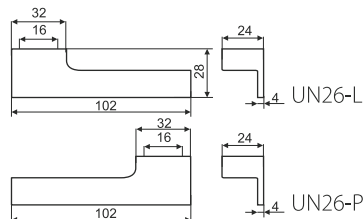

G0004



○ — ○ L - 16 25

UN01 UN01-0032-G0008

ZnAl

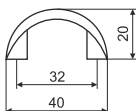

G0004 G0006 G0008 G0003*



○ — ○ L - 32 100

UU74 UU74-0016-G0006

ZnAl

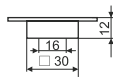

G0004 G0006 G0008



○ — ○ L - 16 100

UN77 UN77-0016-G0006

ZnAl

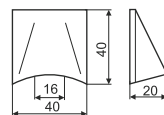

G0006 G0008



○ — ○ L - 16 50

UN29* UN29-0032-G0004

ZnAl

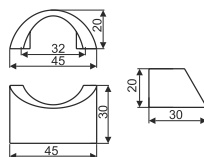

G0004 G0006

○ — ○ L - 32 50

UN94 UN94-0128-G0008
ZnAl

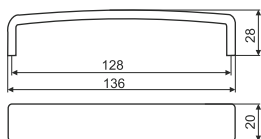

○ → ○ L-128 25

UN45 UN45-0096-G0006
ZnAl

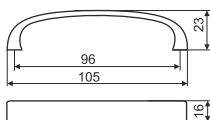

○ → ○ L-64 100
○ → ○ L-96, 128 50

UN42 UN42-0160-G0004
ZnAl

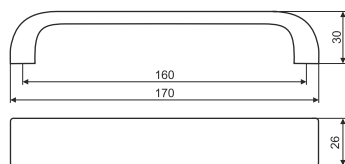

○ → ○ L-160 10

UZ94 UZ94-0128-G0004
ZnAl

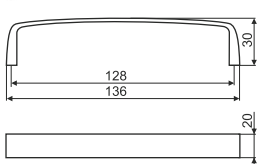

○ → ○ L-128 50

UT43 UT43-0128-G0006
ZnAl

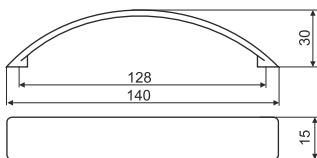

○ → ○ L-128 100

UG43 UG43-0128-G0006
ZnAl

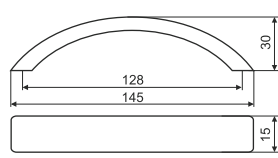

○ → ○ L-96, 128 100

UN48 UN48-0128-G0006

ZnAl

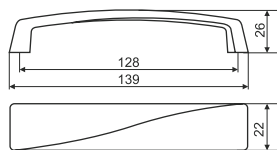

- → ○ L - 96 50
- → ○ L - 128 25
- → ○ L - 160 20

UU10 UU10-0064-G0004

ZnAl

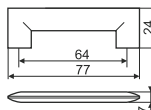

- → ○ L - 64 50

NARVI
US91 US91-0096-G0007

ZnAl

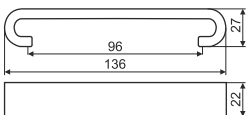

- → ○ L - 96, 128 10

NARVI
GS91 GS91-G0007

ZnAl

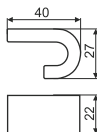

UN92 UN92-0096-G0007

ZnAl

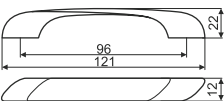

- → ○ L - 64 100
- → ○ L - 96, 128 50



HYDRA
UR27 UR27-0128-G0006
ZnAl

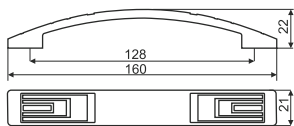

○ → ○ L - 128 50

HYDRA
GR27 GR27-GAB02
ZnAl

i 157

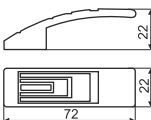

WAVE
UU40 UU40-0192-G0004
ZnAl

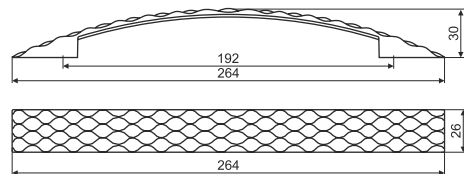

○ → ○ L - 128, 160, 192, 224 25

WAVE
GU40 GU40-G0004
ZnAl

i 168

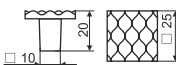

UG41* UG41-0128-G0008
ZnAl

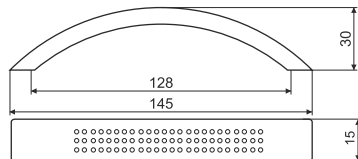

○ → ○ L - 128 100

TALIA
UN87 UN87-0096-G0008
ZnAl

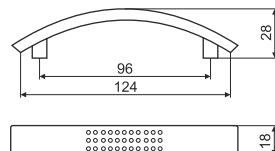

○ → ○ L - 96 50
○ → ○ L - 128 25

HILL
UU16 UU16-0128-G0004
ZnAl

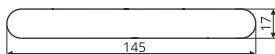
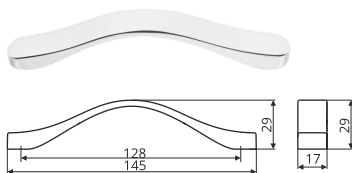

- — ○ L - 128, 160, 192 50
- — ○ L - 320 25

ARCADA
UA91 UA91-0128-G0004
Al

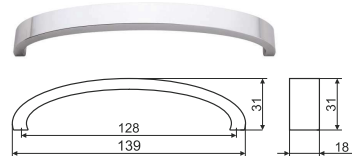

- — ○ L - 32, 128, 160 50

US16 US16-0160-G0006
ZnAl

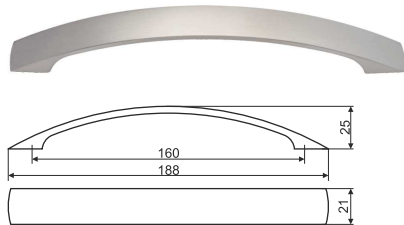

- — ○ L - 160 50

PONTE
UU03 UU03-0160-G0007
ZnAl

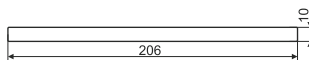
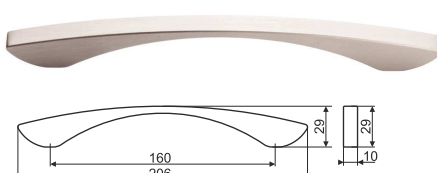

- — ○ L - 128, 160 50
- — ○ L - 320 25

ARCADA
UA91 UA91-0032-G0006
Al

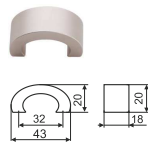

- — ○ L - 32, 128, 160 50

NASTRO
UU13 UU13-0160-G0007
ZnAl

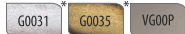
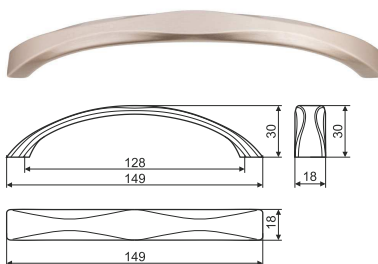

- — ○ L - 128, 160 50



UN06 UN06-0096-G0006

ZnAl

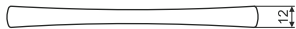
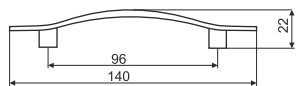

○ → L - 96 100

UN80* UN80-0128-G0004

ZnAl

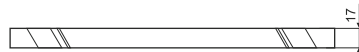
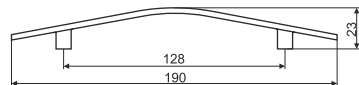

○ → L - 128 50

UN81 UN81-0128-G0007

ZnAl

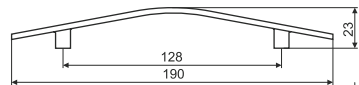

○ → L - 128 50

SLIM LINE

UN35 UN35-0128-G0008

ZnAl

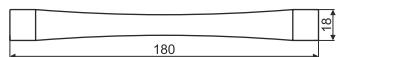
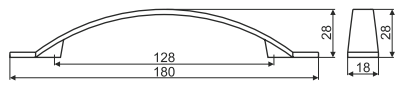

○ → L - 128 50

UU09 UU09-0128-G0007

ZnAl

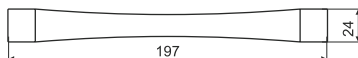
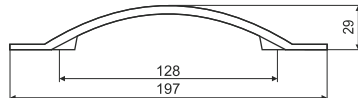

○ → L - 128 50

PUENTE
UN04 UN04-0096-G0006
ZnAl

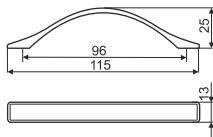

○ → L - 96 100

PUENTE
GN04 GN04-G0008
ZnAl



ALFA
UG44 UG44-0096-G0008
ZnAl

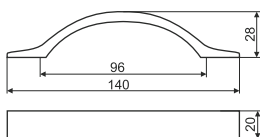

○ → L - 96 100

ALFA
GG44 GG44-G0008
ZnAl

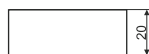
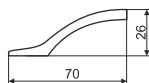

ATRIA
UG39 UG39-0096-G0008
ZnAl

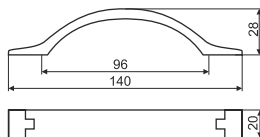

○ → L - 96 50

ATRIA
GG39 GG39-G0008
ZnAl

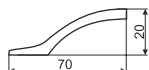

US29 US29-0096-G0006

ZnAl

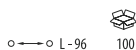
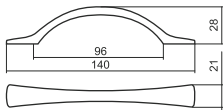

US14 US14-0032-G0004

ZnAl

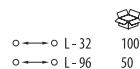
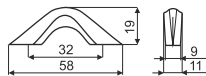

UN62 UN62-0160-G0004

ZnAl

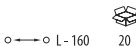
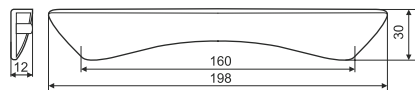

SLIM LINE

UN38 UN38-0096-G0008

ZnAl

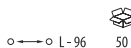
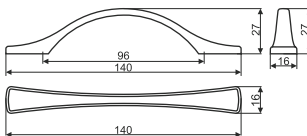

ANTON
UN89 UN89-0064-G0004

ZnAl

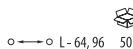
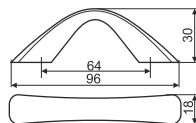

FERROX
UR28 UR28-0096-G0008

ZnAl

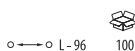
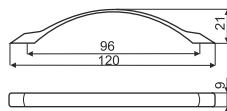

UN13 UN13-0128-G0008
ZnAl

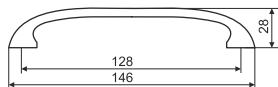

UN14 UN14-0096-G0007
ZnAl

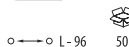
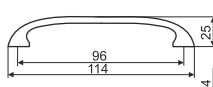

UN51 UN51-0128-G0008
ZnAl

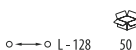
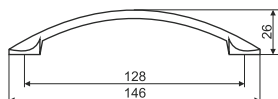

UN96 UN96-0096-G0006
ZnAl

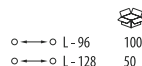
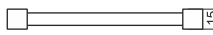
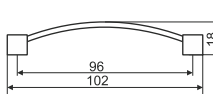

UN97 UN97-0128-G0008
ZnAl

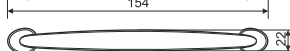

SLIM LINE
UN36 UN36-0128-G0004
ZnAl

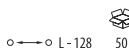
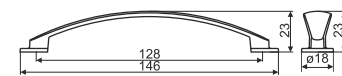

UN40 UN40-0128-G0006

ZnAl

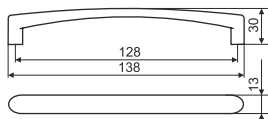

US10 US10-0080-G0006

Stal / Steel / Stahl / Сталь / Acero / Acier

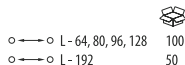
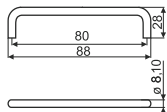

UP38 UP38-0128-G0006

ZnAl

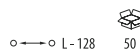
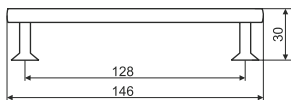

UN43 UN43-0096-G0004

ZnAl

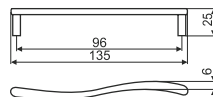

UN07 UN07-0096-G0004

ZnAl

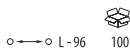
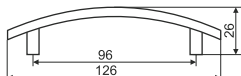

UP83 UP83-0064-G0004
ZnAl

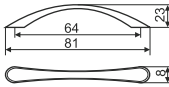

○ → L - 64 100

UP82 UP82-0096-G0008
ZnAl

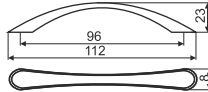

○ → L - 96 100

UP81 UP81-0128-G0006
ZnAl

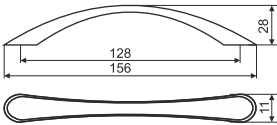

○ → L - 128 50

UP85 UP85-0160-G0004
ZnAl

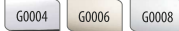
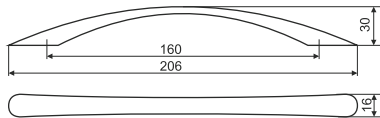

○ → L - 160 50

UP84 UP84-0224-G0004
ZnAl

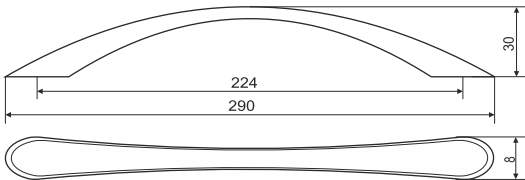

○ → L - 224 50



US26 US26-0096-G0006

ZnAl

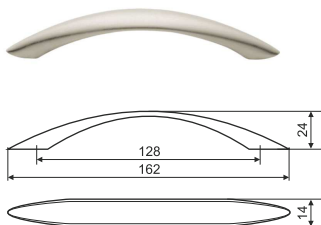

- — L - 96, 128 100
- — L - 192 50

US27 US27-0096-G0006

ZnAl

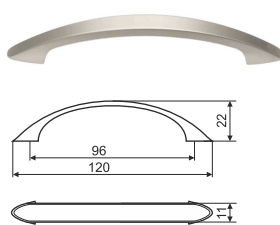

- — L - 96 100

UN91 UN91-0096-G0008

ZnAl

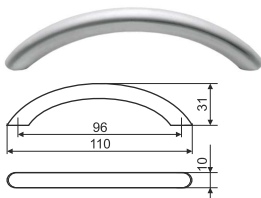

- — L - 96, 128 50

UN83 UN83-0128-G0006

ZnAl

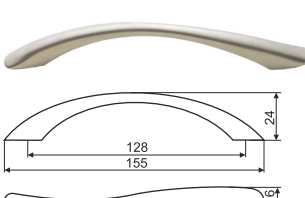

- — L - 64 100
- — L - 96, 128 50

US05 US05-0096-G0004

ZnAl

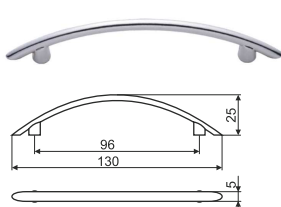

- — L - 96 100

US24 US24-0128-G0007

ZnAl

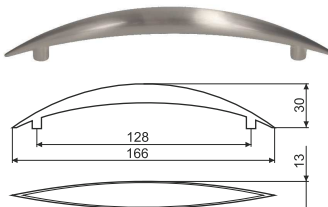

- — L - 128 100

TITAN
UG38 UG38-0128-G0007
ZnAl

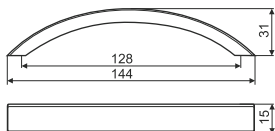

○ → ○ L - 128 100

TITAN
UU37 UU37-0224-G0007
ZnAl

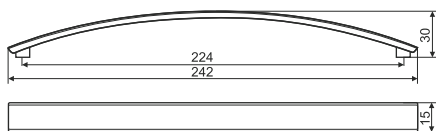

○ → ○ L - 224 50

US09 US09-0128-G0006
ZnAl

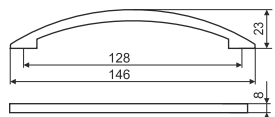

○ → ○ L - 128 100

UN88 UN88-0096-G0007
ZnAl

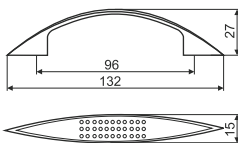

○ → ○ L - 96, 128 50

UP10 UP10-0032-G0004
Al

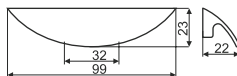

○ → ○ L - 32 50

UN18 UN18-0096-G0006

ZnAl

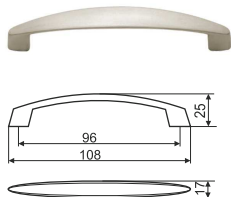

○ → ○ L-96 50

UN17 UN17-0128-G0006

ZnAl

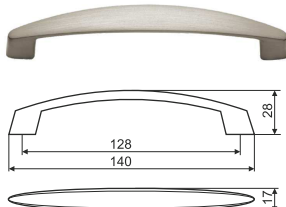

○ → ○ L-128 100

UN90 UN90-0128-G0004

ZnAl

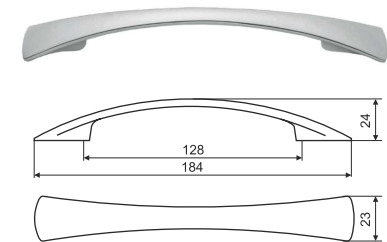

○ → ○ L-96 50
○ → ○ L-128 25

UN54 UN54-0128-G0007

ZnAl

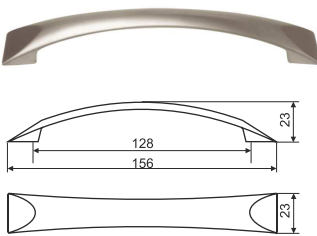

○ → ○ L-128 50

SLIM LINE

UN37 UN37-0128-G0007

ZnAl

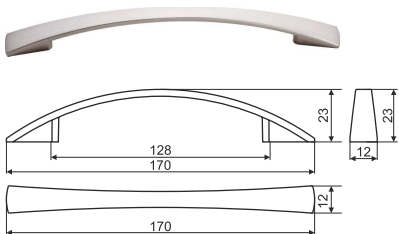

○ → ○ L-96, 128, 160 50



UA92 UA92-0346-G0004-19

AI

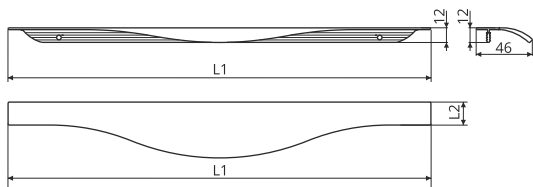

G0004 G0007



L1 (mm)	346	396	446	496	596	796	346	396	446	496	596	796
L2 (mm)	19	19	19	19	19	19	21	21	21	21	21	21

UA110* UA110-0596-A0C00-19

AI

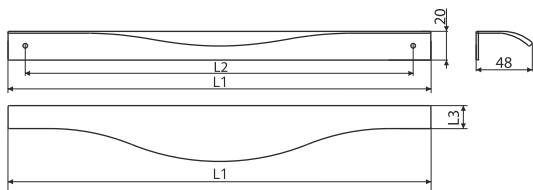

G0004 G0007 A0C00



L1 (mm)	296	346	396	446	496	596	796	896	296	346	396	446	496	596	796	896
L2 (mm)	256	306	356	406	456	556	756	856	256	306	356	406	456	556	756	856
L3 (mm)	19	19	19	19	19	19	19	19	21	21	21	21	21	21	21	21

UA86* UA86-A0C00-297_5-18

Al

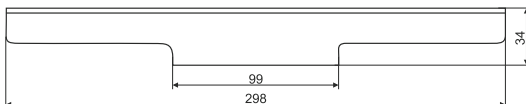
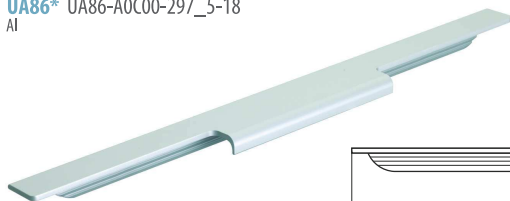

 L - 297,5; 447,5; 497,5; 597,5; 797,5; 897,5 10

UA87* UA87-A0C00-297_5-18

Al

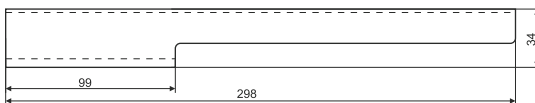
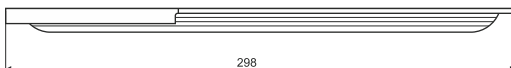
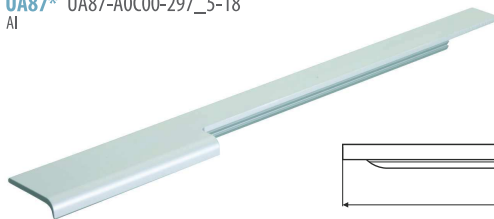

 L - 297,5; 447,5; 497,5; 597,5; 797,5; 897,5 10

UA88* UA88-A0C00-297_5-18

Al

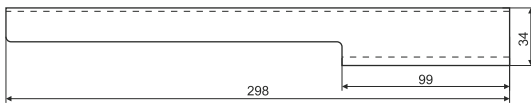
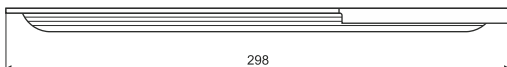
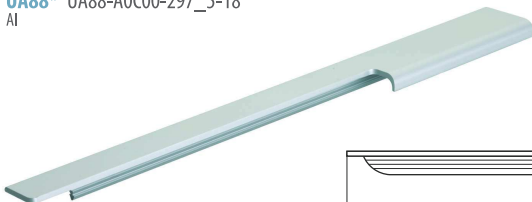

 L - 297,5; 447,5; 497,5; 597,5; 797,5; 897,5 10

PA-UA93 PA-UA93

Al

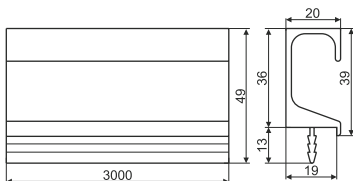

AOC00



PA-UA94 PA-UA94

Al

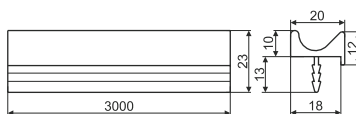

AOC00



PA-UA96 PA-UA96

Al

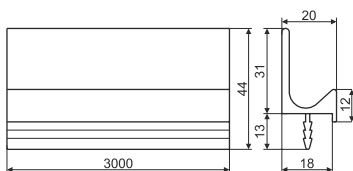

AOC00





GANCHO
US12 US12-0064-G0008
 Stal / Steel / Stahl / Сталь / Acero / Acier

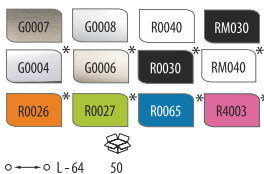
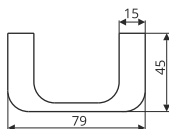
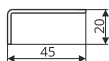
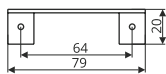

UA68-...-R10 UA68-0060-G0007-0100-R10-2-Y16

Al

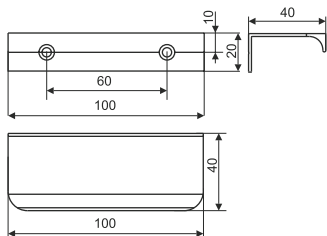

G0004 G0007 A0C00

○ → ○ /  L- 32/60, 32/72, 60/100,
96/150, 128/168, 160/200
L- 210/250, 260/300, 460/500, 660/700



50
25

UA68 UA68-0128-A0C00-0168-2

Al

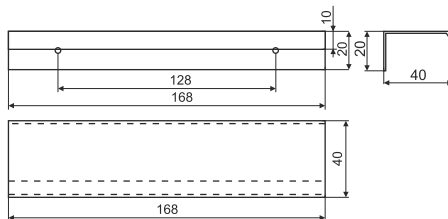
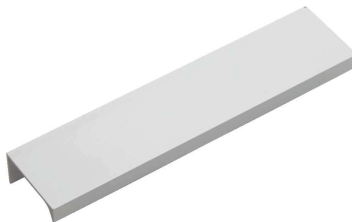

G0004 A0C00 G0007* RM030*

○ → ○ /  L- 32/60, 64/104, 80/120, 96/150, 128/160, 128/168, 160/200 50
L- 192/232, 220/260 260/300 25



50
25

UA57 UA57-0128-A0C00-0168-2

Al

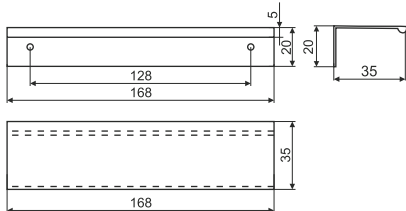

A0C00

○ → ○ /  L- 128/168, 160/200
L- 192/232



50
25

UA45 UA45-0128-A0C00-0168-2

Al

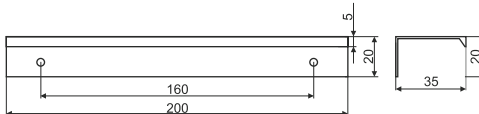

G0004 G0007 A0C00 RM030*

○ → ○ /  L- 32/72, 64/104, 80/120, 96/140, 128/168, 160/200 50
L- 192/232, 260/300, 450/500, 660/700 25
L- 3500 20



50
25
20

UA58 UA58-0128-A0C00-2

Al

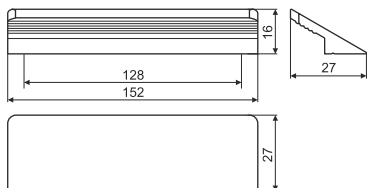

G0004 A0C00



- → ○ L - 128, 160, 192 50
- → ○ L - 288 25

UA01 UA01-0128-A0C00-2

Al

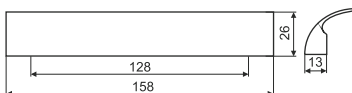
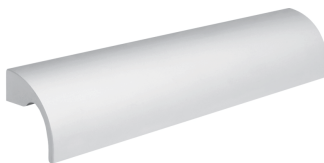

A0C00 RSM08



- L - 64, 96, 128, 160 50

MD14 MD14-0096-G0008

ZnAl

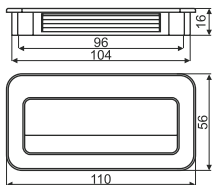

G0006 G0008



- → ○ L - 96 50

UN63 UN63-0128-G0004

ZnAl

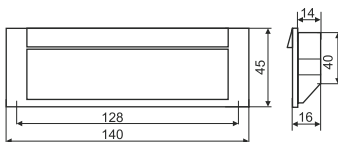

G0004 G0006 G0008



- L - 128 25

UN50 UN50-0096-G0008
ZnAl

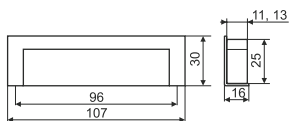

L - 96, 128

25

UA08 UA08-0096-G0004-A0C00
ZnAl + Al

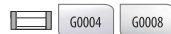
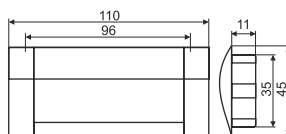

L - 64, 96, 128, 160

20

MD04* MD04-G0004
ZnAl

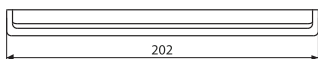
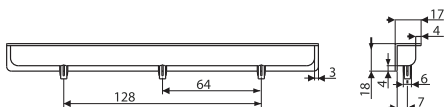

50

MD11 MD11-0128-G0008
ZnAl

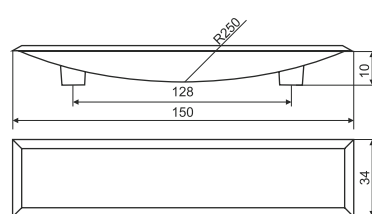

L - 128

50



MD01 MD01-G0004

ZnAl

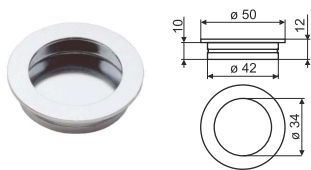

50

MD02 MD02-G0003

ZnAl

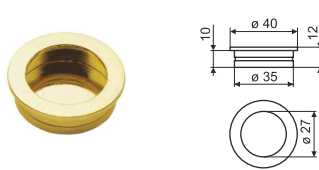

100

MD61 MD61-P0004

Tworzywo / Plastic / Kunststoff /
Пластмасса / Plástico / Plastique

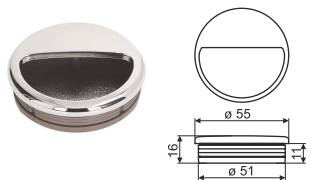

50

MD03 MD03-G0008

ZnAl

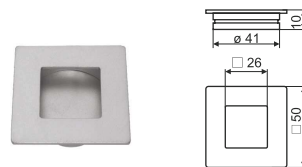

50

MD13 MD13-0076-G0008

ZnAl

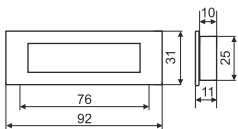

L-76 25

MD12 MD12-0096-G0006

ZnAl

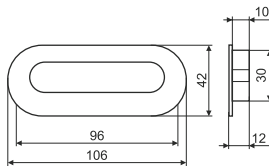

L-96 25

UD23 UD23-0096-D60

Drewno / Wood / Holz / Дерево / Madera / Bois

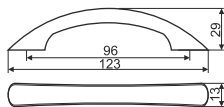

○ → L - 96 100

UD24* UD24-0096-D10

Drewno / Wood / Holz / Дерево / Madera / Bois

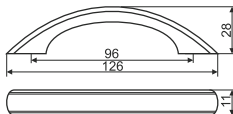

○ → L - 96 100

US62* US62-0096-G0006-D13

ZnAl

+ Drewno / Wood / Holz / Дерево / Madera / Bois

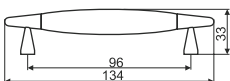

○ → L - 96, 128 100

UF19* UF19-0128-G0004-PF10

ZnAl

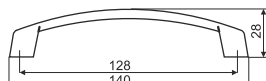
+ Tworzywo / Plastic / Kunststoff
Пластмасса / Plástico / Plastique

○ → L - 128 50

UF89* UF89-0128-P0008-PF14-B

ZnAl

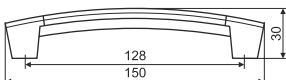
+ Tworzywo / Plastic / Kunststoff
Пластмасса / Plástico / Plastique

○ → L - 128 50

UD25 UD25-0096-D40

Drewno / Wood / Holz / Дерево / Madera / Bois

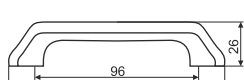

○ → L - 96 100

UX02 UX02-0096-RSM08

Tworzywo / Plastic / Kunststoff
Пластмасса / Plástico / Plastique

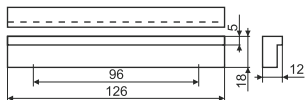

RSM08 P30



○ — ○ L - 96, 128 100

UX04 UX04-0128-RSM08

Tworzywo / Plastic / Kunststoff
Пластмасса / Plástico / Plastique

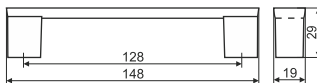

RSM06 RSM08



○ — ○ L - 128, 160 50

UX05 UX05-0160-RSM08

Tworzywo / Plastic / Kunststoff
Пластмасса / Plástico / Plastique

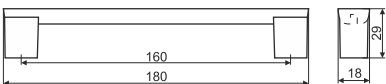

RSM08



○ — ○ L - 128, 160 50

UX03 UX03-0160-RSM06

Tworzywo / Plastic / Kunststoff
Пластмасса / Plástico / Plastique

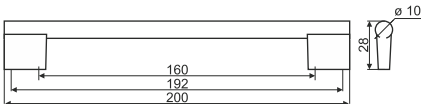

RSM06 RSM08



○ — ○ L - 160 100

UX11 UX11-0096-RSM08

Tworzywo / Plastic / Kunststoff
Пластмасса / Plástico / Plastique

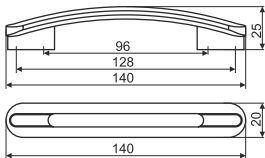

RSM08



○ — ○ L - 96 50

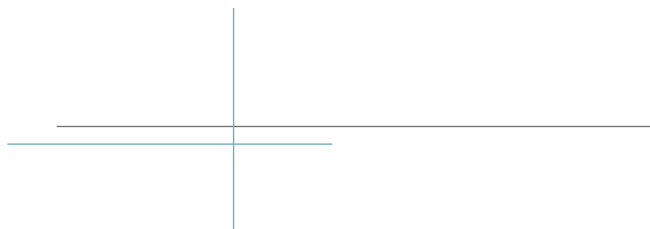

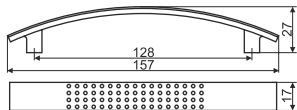
UX87 UX87-0128-RSM06Tworzywo / Plastic / Kunststoff
Пластмасса / Plástico / Plastique

RSM06 RSM08

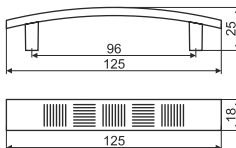

○ → ○ L - 96, 128 100

UX12 UX12-0096-RSM08Tworzywo / Plastic / Kunststoff
Пластмасса / Plástico / Plastique

RSM08

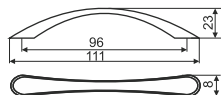

○ → ○ L - 96 50

UX82 UX82-0096-RSM08Tworzywo / Plastic / Kunststoff
Пластмасса / Plástico / Plastique

RSM08

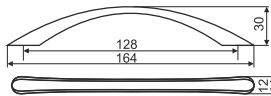

○ → ○ L - 96 100

US81 US81-0128-P30Tworzywo / Plastic / Kunststoff
Пластмасса / Plástico / Plastique

RSM08 P20 P30* P40*



○ → ○ L - 128 100



BAROCCO

UR25 UR25-0128-G0031-G0004

ZnAl

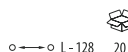
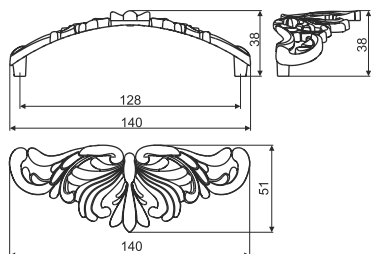

BAROCCO

UR25 UR25-0032-GNE03-G0003

ZnAl

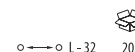
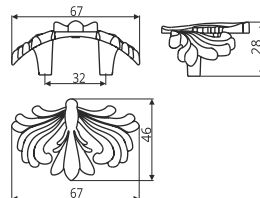

** Na specjalne zamówienie dostępne są inne wersje kolorystyczne :: Other colours available on request :: Andere Farboptionen sind auf individuelle Anfrage möglich. :: Разные цветовые варианты возможны по индивидуальному заказу :: Otros colores disponibles bajo pedido :: Les autres couleurs sont disponibles sur demande

TRECCIA

UR46 UR46-0128-G0035

ZnAl

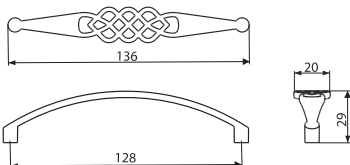

TRECCIA

GR46 GR46-G0005

ZnAl

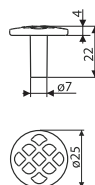

* Na specjalne zamówienie :: Available on request :: Auf individuelle Anfrage :: На индивидуальный заказ :: Bajo pedido :: Sur commande

ANIMA CRISTAL

UR40-...-SW UR40-0128-G0004-SW

ZnAl

ANIMA CRISTAL

UR40-...-SW UR40-0032-G0004-SW

ZnAl

made with Crystals from Swarovski®

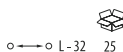
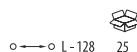
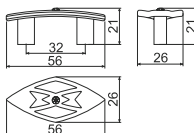
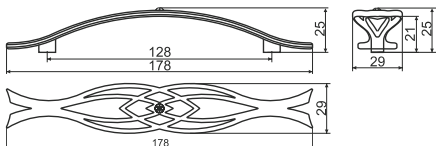

ANIMA

UR40 UR40-0128-G0031

ZnAl

ANIMA

UR40 UR40-0032-G0031

ZnAl

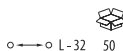
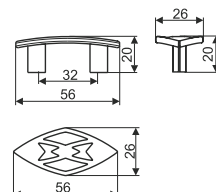
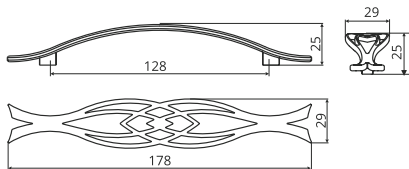

ONDA CRISTAL
UR32-...-SW2 UR32-0128-G0035-SW2
 ZnAl

ONDA CRISTAL
GR32-...-SW GR32-G0004-SW   177
 ZnAl

made with Crystals from Swarovski®

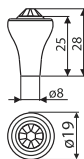
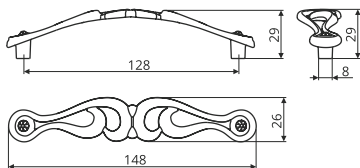

○ → L-128 25

ONDA
UR32 UR32-0128-G0031
 ZnAl

ONDA
GR32 GR32-G0005   177
 ZnAl

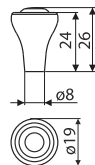
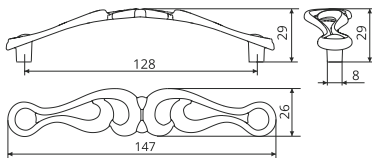

○ → L-128 50

TESSERE
UR26 UR26-0128-G0004
 ZnAl

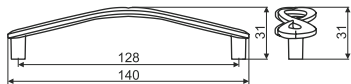

○ — L - 96, 128 50

TESSERE
GW26 GW26-G0005
 ZnAl

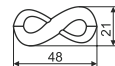
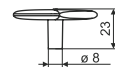

TESSERE CRISTAL
UR26-...-SW2 UR26-0128-G0004-SW2
 ZnAl



UR26-...-SW2

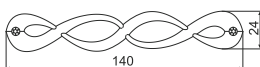
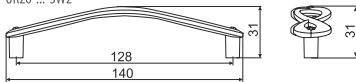

UR26-...-SW3

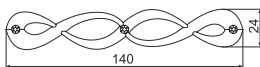
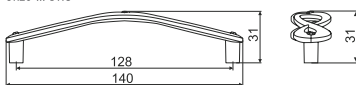

○ — L - 96, 128 25

TESSERE CRISTAL
GW26-...-SW GW26-G0035-SW
 ZnAl

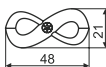
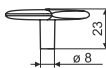

made with Crystals from Swarovski®



ANGELO
UR36 UR36-0128-G0035
 ZnAl

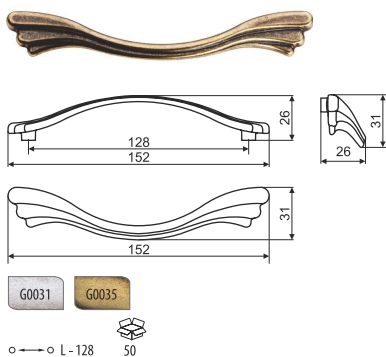

ANGELO
GR36 GR36-G0031
 ZnAl

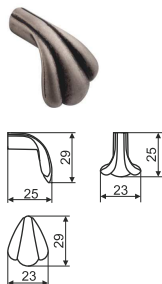

SORRISO
UR19 UR19-0128-GA011
 ZnAl

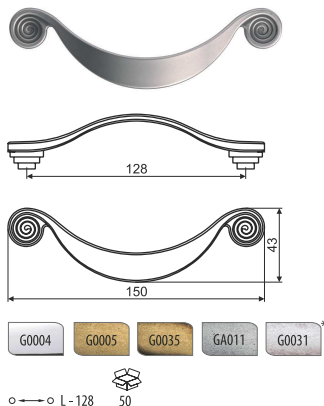

SORRISO
GW19 GW19-G0035
 ZnAl

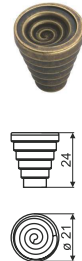

SORRISO CRISTAL
UR19-...-SW UR19-0128-G0035-SW
 ZnAl

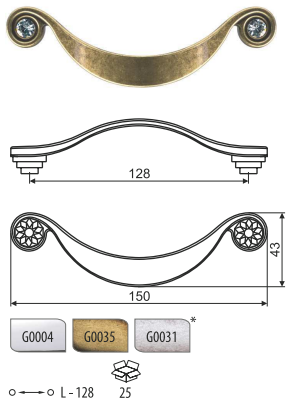

SORRISO CRISTAL
GW19-...-SW GW19-G0004-SW
 ZnAl



made with Crystals from Swarovski®

CLASSICO

UR41 UR41-0128-G0031

ZnAl

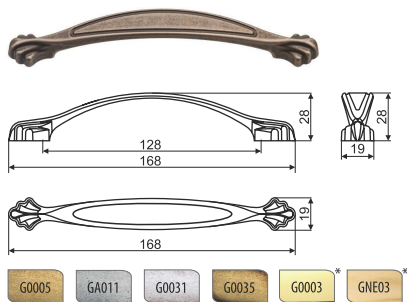

○ — ○ L - 96, 128 50

CLASSICO

GR41 GR41-G0035

ZnAl

i 174

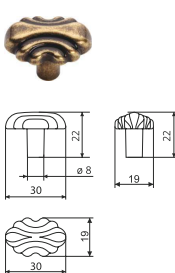

CORDA

UR44 UR44-0128-G0031

ZnAl

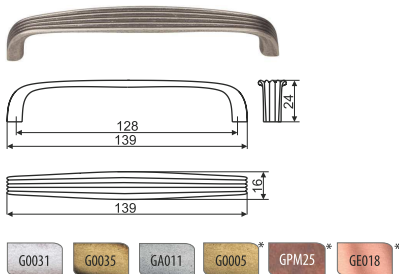

○ — ○ L - 96, 128 100

ZAMPA

UR45 UR45-0128-G0031

ZnAl

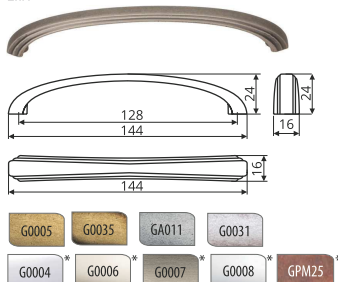

○ — ○ L - 96, 128 100

ANTICO

UR37 UR37-0128-G0031

ZnAl

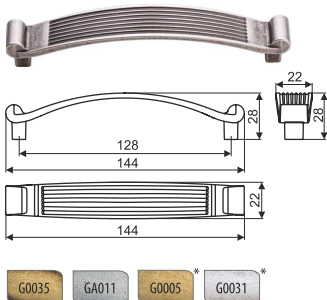

○ — ○ L - 128 50

ANTICO

GR37 GR37-G0035

ZnAl

i 175

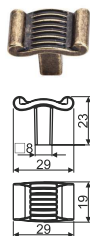

CASTELLO
UR38 UR38-0128-G0035
 ZnAl

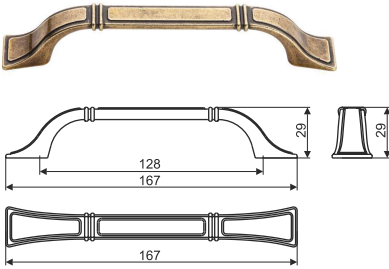

○ → L - 128 50

DIVINO
UR42 UR42-0128-G0035
 ZnAl

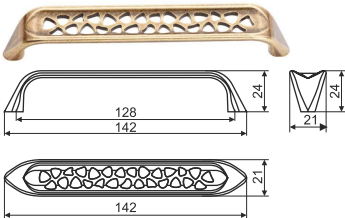

○ → L - 128 50

MARITIMO
UR15 UR15-0096-G0005
 ZnAl

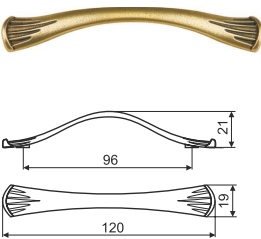

○ → L - 96, 128 50

CASTELLO
GR38 GR38-G0031
 ZnAl

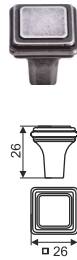

DIVINO
UR42 UR42-0032-G0031
 ZnAl

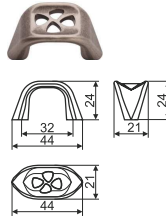

○ → L - 32 50

MARITIMO
GR15 GR15-G0005
 ZnAl

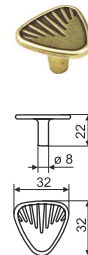

SIPARIO
RE23 RE23-0160-G0031

ZnAl
+ Stal / Steel / Stahl / Сталь / Acero / Acier

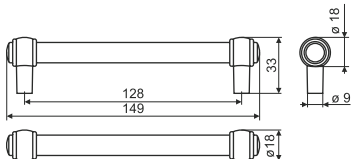

- — L - 96, 128 50
- — L - 160, 192, 256, 320, 448, 480 20

SIPARIO
GW23 GW23-G0031

ZnAl

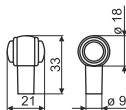

SIPARIO CRISTAL
RE23-...-SW RE23-0096-G0035-SW

ZnAl
+ Stal / Steel / Stahl / Сталь / Acero / Acier

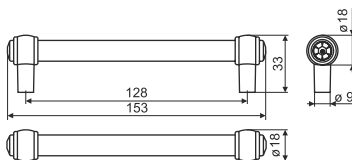

- — L - 96, 128 50
- — L - 160, 192, 256, 320, 448, 480 20

HANTLE
UU15 UU15-0192-G0031

ZnAl

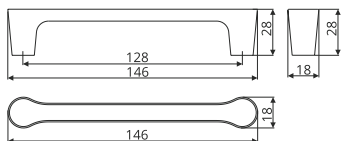

- — L - 128, 160 50
- — L - 192, 224, 320 25

SIPARIO CRISTAL
GW23-...-SW GW23-G0035-SW

ZnAl



made with Crystals from Swarovski®

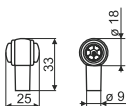

HANTLE
UU15 UU15-0128-G0035

ZnAl



ARUM
UR16 UR16-0096-G0005
ZnAl

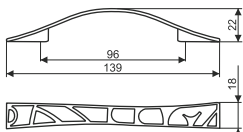

○ → L-96 100

ARUM
GR16 GR16-G0005   176
ZnAl



TENUE
UR24 UR24-0096-GAE02
ZnAl

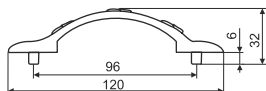

○ → L-96 50

TENUE
GR24 GR24-GAE02   172
ZnAl



CREAVI
UR20 UR20-0096-GAE02
ZnAl

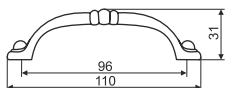

○ → L-96 50

CREAVI
KR20 KR20-GAE02   179
ZnAl

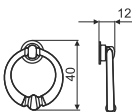

BOW
UN31 UN31-0192-G0031
ZnAl

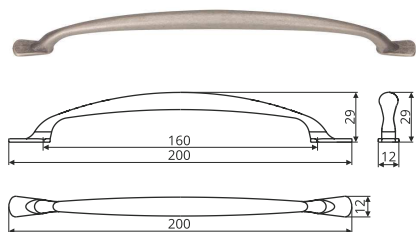

○ → L - 128, 160, 192
50

US28 US28-0096-G0006
ZnAl

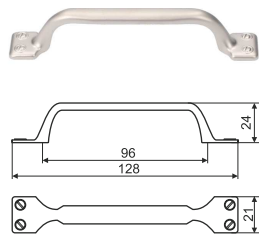

○ → L - 96
100

UR07 UR07-0096-G0005
ZnAl

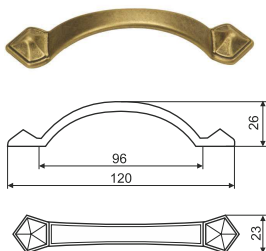

○ → L - 96
100

UR10 UR10-0096-G0005
ZnAl

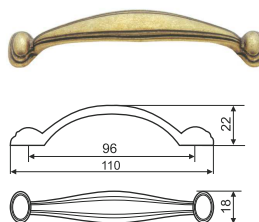

○ → L - 96
100

ATENA
UG32 UG32-0096-G0005
ZnAl

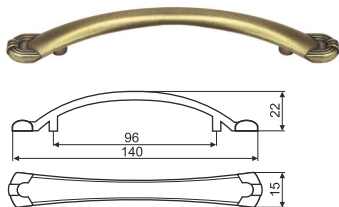

○ → L - 96
100

ATENA
GG32 GG32-G0005
ZnAl

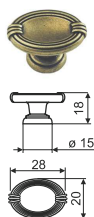

i 174

APASIONADO
UR33 UR33-0096-G0005
 ZnAl

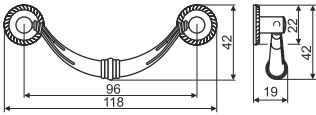

APASIONADO
GR33 GR33-G0005
 ZnAl

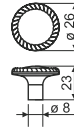

APASIONADO
KR33 KR33-G0005
 ZnAl

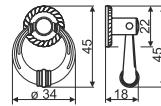

RUSTICO
UR21 UR21-0080-GAE02
 ZnAl

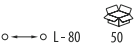
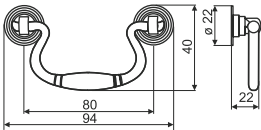

RUSTICO
KR21 KR21-GAE02
 ZnAl

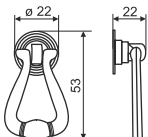

US01 US01-0064-G0005
ZnAl

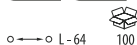
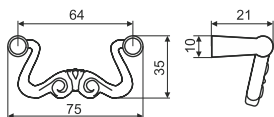

US03 US03-0080-G0005
ZnAl

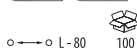
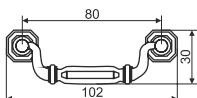

BELI
UU78 UU78-0096-G0005
ZnAl

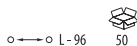
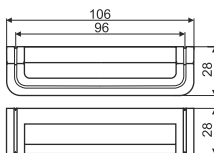

KT05 KT05-G0005   180
ZnAl

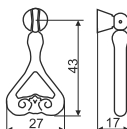

KT03 KT03-G0005   181
ZnAl

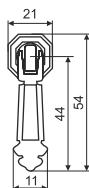

BELI
UU78 UU78-0016-G0005
ZnAl

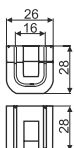

KR08 KR08-G0005
ZnAl

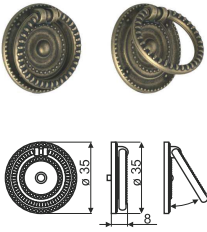

GA011 G0005*



KR07* KR07-G0005
ZnAl

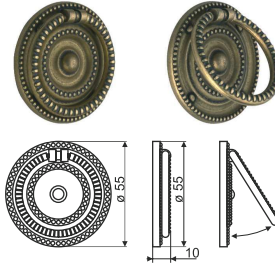

G0005 GA011



ROTA
KR13 KR13-G0005
ZnAl



G0005

KN98 KN98-G00AB
ZnAl

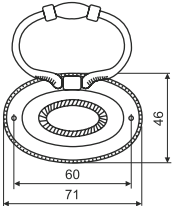

G00AB

UR11 UR11-0055-G0005
ZnAl

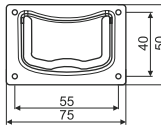

G0005 GA011

L-55

UP01 UP01-0064-G00AB
ZnAl

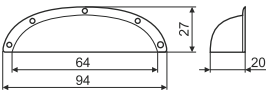

G0004 G00AB

L-64

SHELL
UP11 UP11-0128-GAB02
ZnAl

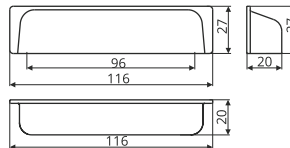

G0004 G0006 G0007 G0031 G0008*
GE018* G0005* G0035* GAB02* GPM25*

L-32, 64, 96, 128

DECOR
UN03* UN03-0064-GAB02-L
ZnAl

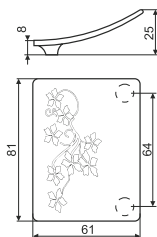

DECOR
GU03 GU03-GAB02-L **i** 175
ZnAl

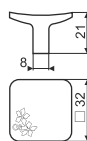

ARCANUM
UR29 UR29-0096-G0009
ZnAl

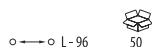
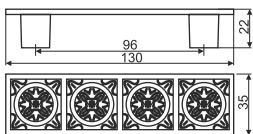

ARCANUM
GR29 GR29-GA011
ZnAl

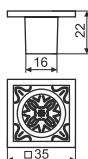

ARCANUM
WR29 WR29-0032-G0005
ZnAl

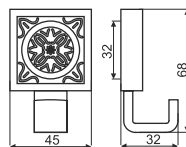

VITREO
UR22 UR22-0128-G0005
 ZnAl

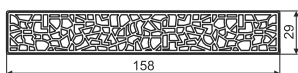
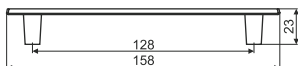

VITREO
GR02 GR02-GE009
 ZnAl

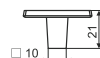

PARK
UU75 UU75-0096-G0005
 ZnAl

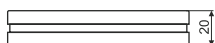
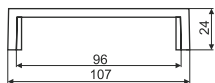

PARK
GU75 GU75-G0005
 ZnAl

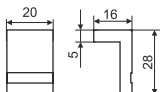

SERPENTE
UR43 UR43-0128-G0005
 ZnAl

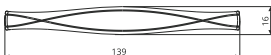
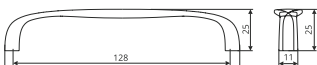

UR09
 ZnAl UR09-0096-G0005

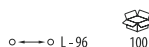
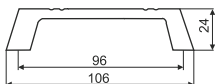

HELIOS
UG17 UG17-0096-G0005
 ZnAl

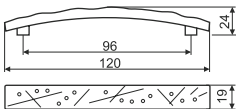

G0005



○ → L - 96

HELIOS
GG16 GG16-G0005   173
 ZnAl



RUBICON
UG30 UG30-0096-G0005
 ZnAl

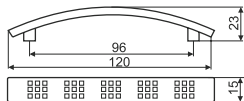

G0005



○ → L - 96

DAFNE
UG19 UG19-0096-G0005
 ZnAl

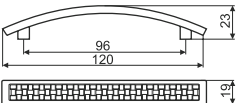

G0005

G0006

GA011



○ → L - 96

DAFNE
GR10 GR10-G0005   175
 ZnAl



ORIENT
UR05 UR05-0064-G0005
 ZnAl

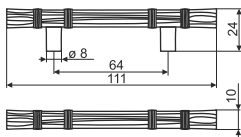

ORIENT
GR03 GR03-G0005   174
 ZnAl

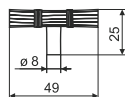

UR03 UR03-0096-G0005
 ZnAl

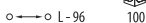
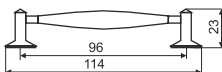

RETICULI
UC01 UC01-0096-G00AB
 Stal / Steel / Stahl / Сталь / Acero / Acier

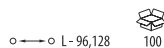
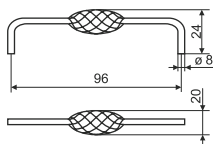

RETICULI
GC01 GC01-GA011   179
 Stal / Steel / Stahl / Сталь / Acero / Acier

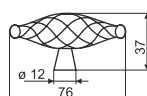



BELLO
UP17 UP17-0128-G00AB-MLK-17

ZnAl
+Polcelana / Porcelain / Porzellan
Φαρφop / Porcelana / Porcelaine

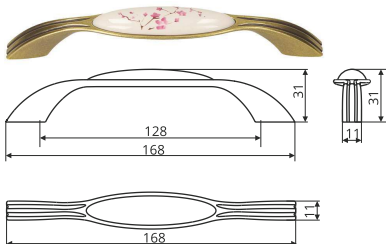

	GA011		WHT		MLK	0	16	
	G00AB		WHT		MLK	0	16	
	G00AB		WHT		MLK	0	17	

→ L - 96 50
○ → L - 128 25

VICTORIA
GP19 GP19-G00AB-MLK-17

ZnAl
+Polcelana / Porcelain / Porzellan
Φαρφop / Porcelana / Porcelaine

i 182



VICTORIA
GP19 GP19-GA011-WHT-16

ZnAl
+Polcelana / Porcelain / Porzellan / Φαρφop / Porcelana / Porcelaine

i 182



VICTORIA
UP19 UP19-0096-GA011-WHT-16

ZnAl
+Polcelana / Porcelain / Porzellan / Φαρφop / Porcelana / Porcelaine

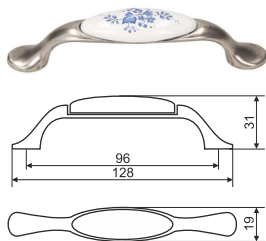

	GA011		MLK	0	1		2		3		4	
	GA011		WHT	12		16						
	G00AB		WHT	16		17						
	G00AB		MLK	0	1		2		3		4	
				10		11		17				

○ → L - 96 50

ELISA
UP20 UP20-0096-G00AB-MLK-2

ZnAl
+Polcelana / Porcelain / Porzellan / Φαρφορ / Porcelana / Porcelaine

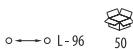
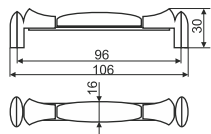

ELISA
GP20 GP20-MLK-0   182

ZnAl
+Polcelana / Porcelain / Porzellan / Φαρφορ / Porcelana / Porcelaine

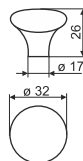

SABINE
UP21 UP21-0096-GA011-MLK-3

ZnAl
+Polcelana / Porcelain / Porzellan / Φαρφορ / Porcelana / Porcelaine

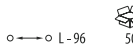
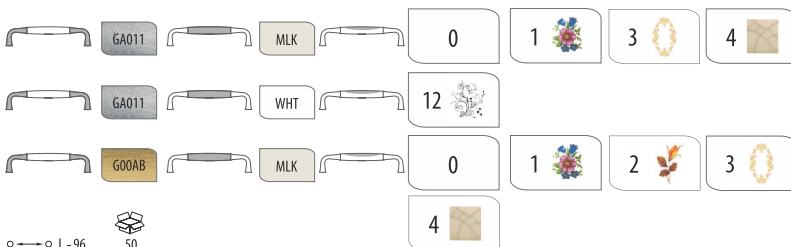
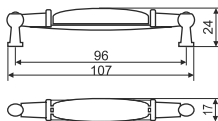

SABINE
GP21 GP21-MLK-3   182

ZnAl
+Polcelana / Porcelain / Porzellan / Φαρφορ / Porcelana / Porcelaine

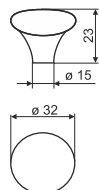

SCANDI

UP16 UP16-0128-G00AB-MLK-0

ZnAl
+Polcelana / Porcelain / Porzellan / Φαρφορ / Porcelana / Porcelaine

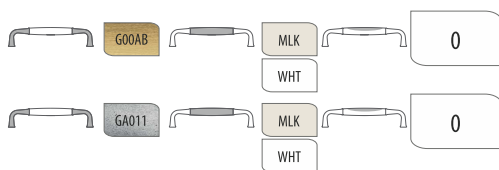
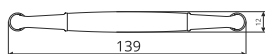
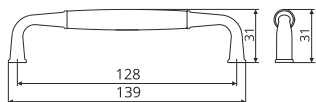

○ → ○ L-128 50



UP03 UP03-0128-GAE02-WHT-5

ZnAl
+Polcelana / Porcelain / Porzellan / Φαρφορ / Porcelana / Porcelaine

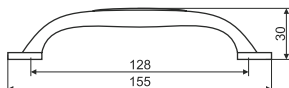

○ → ○ L-128 25

GP03 GP03-GAE02-WHT-5 183

ZnAl
+Polcelana / Porcelain / Porzellan / Φαρφορ / Porcelana / Porcelaine

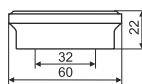



CAMELEON

UU06 UU06-0032-G0004-P41

ZnAl

+Tworzywo / Plastic / Kunststoff / Пластмасса / Plástico / Plastique

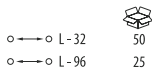
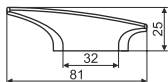

CAMELEON

UU07 UU07-0032-G0004-P41

ZnAl

+Tworzywo / Plastic / Kunststoff / Пластмасса / Plástico / Plastique

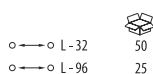
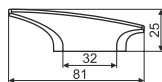

Modular
system

HAPPY FROGS

DU05 DU05-0096-R0027

Tworzywo / Plastic / Kunststoff
Пластика / Plástico / Plastique

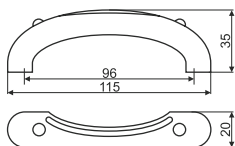

○ — ○ L - 96 50

HAPPY FROGS

DW05 DW05-R0065

Tworzywo / Plastic / Kunststoff
Пластика / Plástico / Plastique

i 196

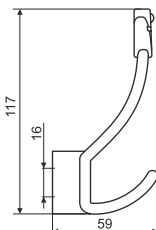
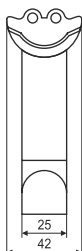

HAPPY FROGS

DG05 DG05-R0026

Tworzywo / Plastic / Kunststoff
Пластика / Plástico / Plastique

i 185

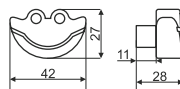

RAINBOW

DG13 DG13-0096-R0026

ZnAl
+Tworzywo / Plastic / Kunststoff / Пластика / Plástico / Plastique

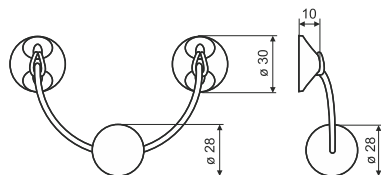
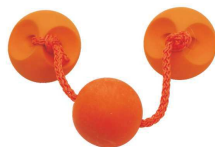

○ — ○ L - 96 50

RAINBOW

DG12 DG12-R0027

ZnAl
+Tworzywo / Plastic / Kunststoff / Пластика / Plástico / Plastique

i 185

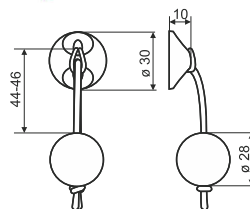
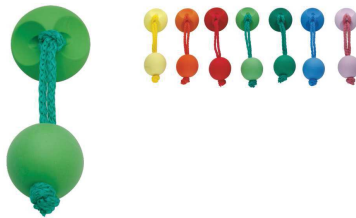

SMILE

UU53 UU53-0128-G0008-T

ZnAl

+Tworzywo / Plastic / Kunststoff / Пластмасса / Plástico / Plastique

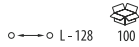
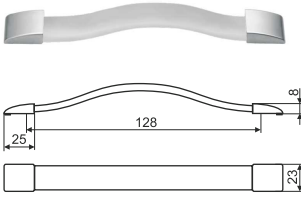

SMILE

GU53 GU53-G0004-T

GU53-G0008-B

ZnAl

+Tworzywo / Plastic / Kunststoff / Пластмасса / Plástico / Plastique

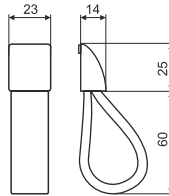

GANCHO

US12 US12-0064-R0026

Stal/Steel/Stahl/Сталь/Acero/Acier

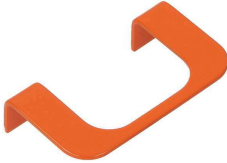

GANCHO

US12 US12-0064-R0027

Stal/Steel/Stahl/Сталь/Acero/Acier



GANCHO

US12 US12-0064-R0065

Stal/Steel/Stahl/Сталь/Acero/Acier



GANCHO

US12 US12-0064-R4003

Stal/Steel/Stahl/Сталь/Acero/Acier

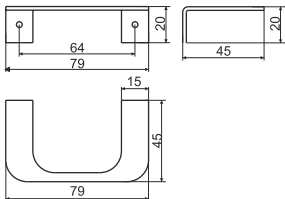

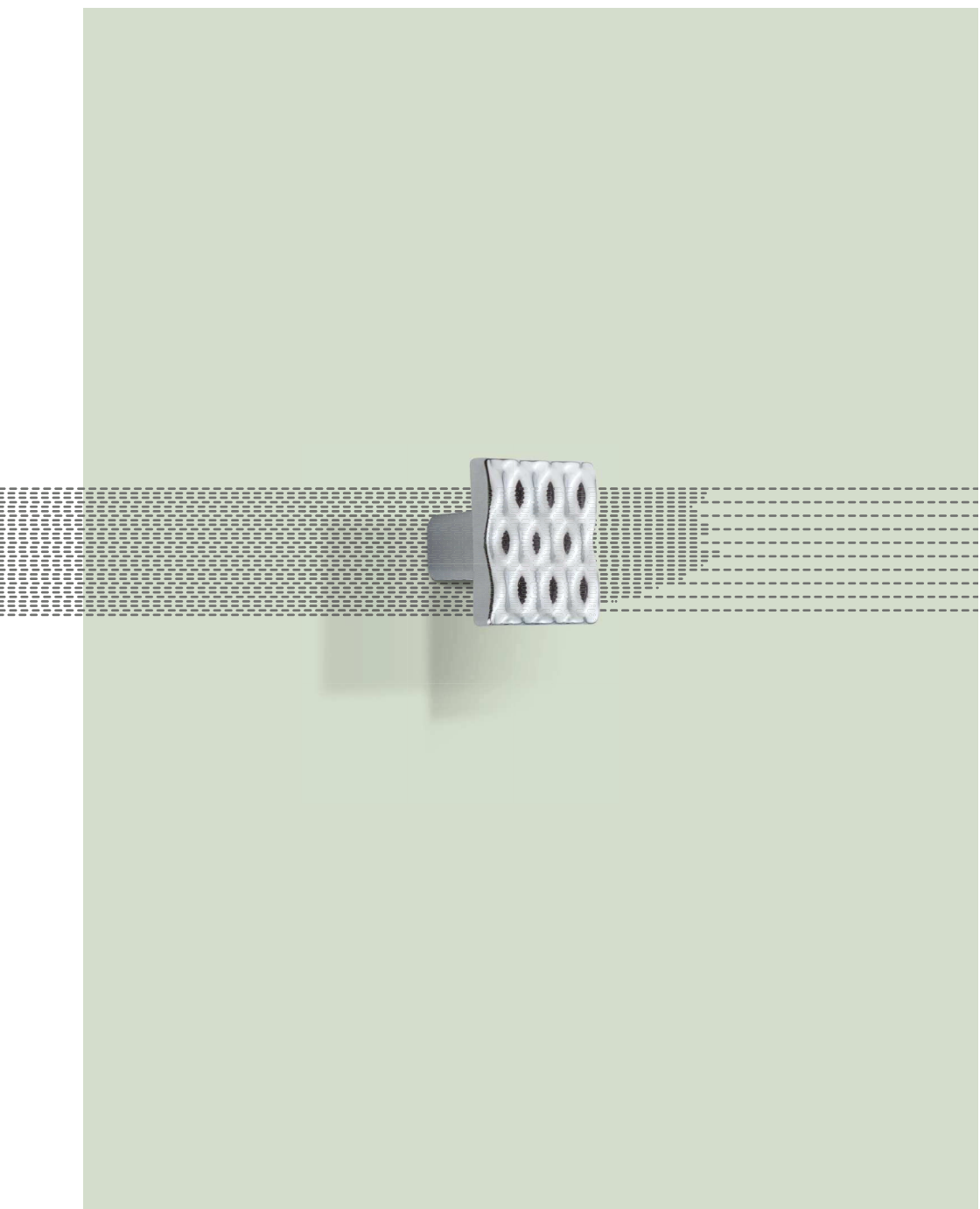



GAMET®

**GAŁKI
KNOBS
KNÖPFE
ΚΗΟΠΚΙ
ΡΟΜΟΣ
ΡΟΜΜΕΑΥΧ**

CAMELEON

UU06 UU06-0032-G0004-P41

ZnAl

+ Tworzywo/Plastic/ Kunststoff/ Пластмасса/ Plástico/ Plastique

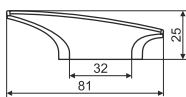

CAMELEON

UU07 UU07-0032-G0004-P31

ZnAl

+ Tworzywo/Plastic/ Kunststoff/ Пластмасса/ Plástico/ Plastique

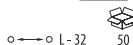
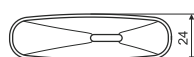
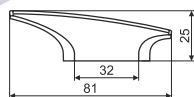

PUZZLE

GL66-1* GL66-1-A0B35-G0008

ZnAl + Al



RITTO

GS48 GS48-APB35-APB35

Al

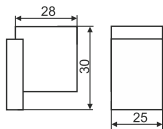

VERSA

GU30 GU30-G0004

ZnAl

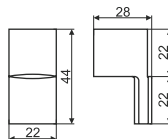

UNIVERSUM
GS24 GS24-G0006
 ZnAl

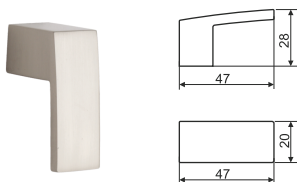

G0006 G0007 G0008



POLARIS
GS92 GS92-G0004
 ZnAl

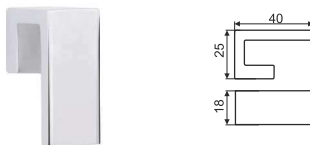

G0004 G0006 G0007 G0008



GG21 GG21-G0008
 ZnAl

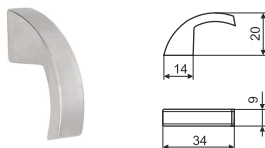

G0006 G0008 G0004*



GG02 GG02-G0006
 ZnAl

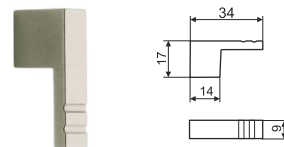

G0006 G0008

G0004*



APODIS
GU22 GU22-G0006
 ZnAl

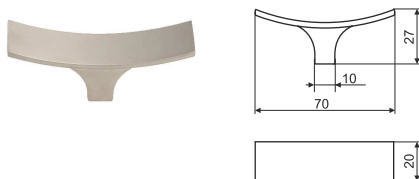

G0006 G0008



HYDRA
GR27 GR27-GAB02
 ZnAl

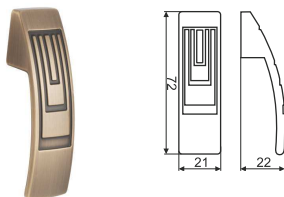

GE009 GAB02 G0008*





ATRIA
GG39-G0008
ZnAl

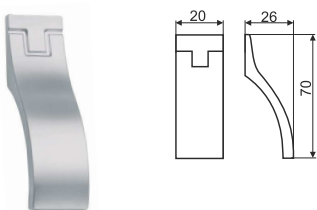

G0006 G0008 G0004* G0005*



100

ALFA
GG44-G0008
ZnAl

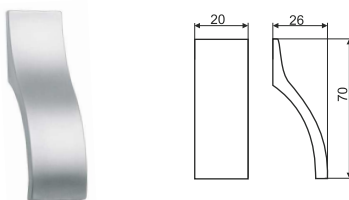

G0006 G0007 G0008



100

NARVI
GS91-G0007
ZnAl

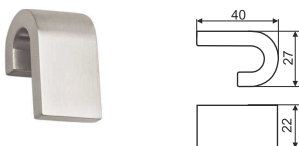

G0006 G0007 G0008 G0004*



25

UN10* UN10-G0006
ZnAl

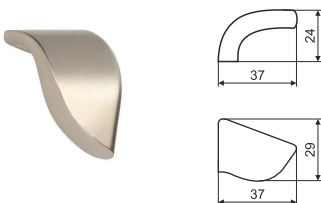

G0006 G0004*



100

QUADRA
RG08-G0008
ZnAl

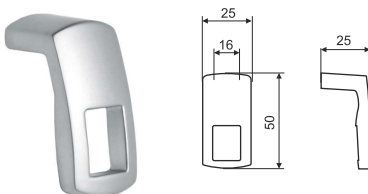

G0004 G0006 G0008 G0007*



25

GG06* GG06-G0008
ZnAl

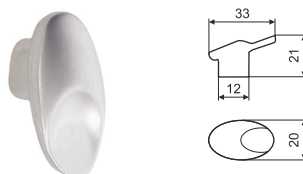

G0003 G0004 G0008



100

SPIRO
GS16 GS16-G0004
 ZnAl

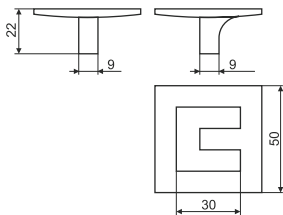

G0004 G0007* G0008*



GN06 GN06-G0008
 ZnAl

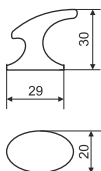

G0004 G0006 G0008 G0003*



GN07 GN07-G0004
 ZnAl

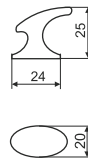

G0004 G0006



GG23 GG23-G0008
 ZnAl

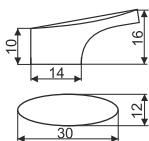

G0006 G0007 G0008



GN68* GN68-G0004
 ZnAl

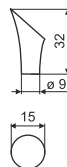

G0004 G0008





GU54 GU54-G0008

ZnAl

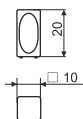

G0004

G0008



100

GL12 GL12-A0C00-0020

Al

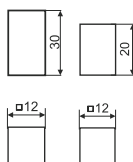

A0C00

H - 20, 30



50

GL10 GL10-AEC00-0030

Al

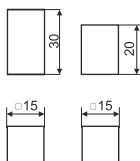

A0C00

AEC00*

H - 20, 30



50

MODERNO

GL46* GL46-0032-A0C00-G0004

Al

+Stal/Steel/ Stahl/ Сталь/ Acero/ Acier

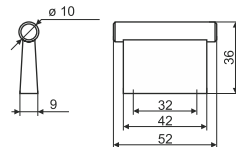

①

A0C00

R0030

②

G0004

G0008

○ → L - 32



50



GL08* GL08-A0C00-0020

Al

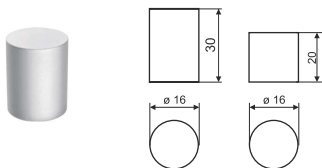

A0C00 RM030

H - 20, 30
50

GA27 GA27-G0006

ZnAl

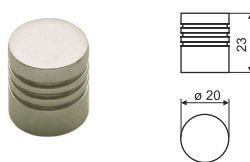

G0004 G0006 G0008

100

GL02 GL02-A0C00

Al



G0004 A0C00

100

SLIM LINE

GS06 GS06-G0007

Stal/Steel/ Stahl/ Сталь/ Acero/ Acier

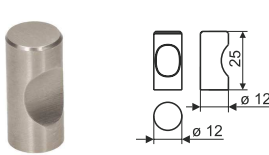

G0007

50

GS05 GS05-G0004

Stal/ Steel/ Stahl/ Сталь/ Acero/ Acier



G0004

100

GN01* GN01-G0004

ZnAl



G0004

100

GG45 GG45-G0004

ZnAl

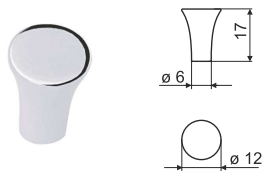

GG50 GG50-G0006

ZnAl



GS02 GS02-G0004

Stal/Steel/ Stahl/ Сталь/ Acero/ Acier



GG01 GG01-G0006

ZnAl

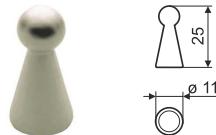

GG10 GG10-G0007

ZnAl



GA28 GA28-G0006

ZnAl

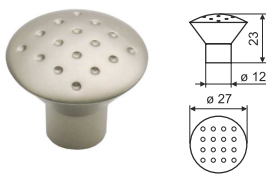

GU56 GU56-G0004
ZnAl

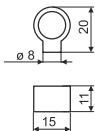

G0004 G0008*



GN10 GN10-G0004
ZnAl

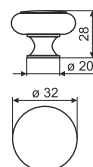

G0004 G0006 G0007
G00AB G0003* G0008*



GA08 GA08-G0004
ZnAl

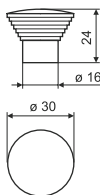

G0003 G0004 G0006 G0008 G0007
R0030 R0040 R0030* R0040*



GA09 GA09-G0004
ZnAl

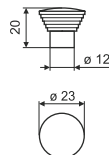

G0003 G0004 G0005 G0006 G0007
G0008 R0030* R0040*



GP16 GP16-G0006
ZnAl

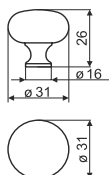

G0003 G0004 G0006
G0007 G0008 G00AB

R0030



SLIM LINE
GP11 GP11-G0007
ZnAl

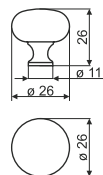

G0004 G0006
G0007 G0008



GN34 GN34-G0003

ZnAl

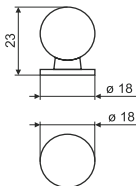

GN32 GN32-G0006

ZnAl

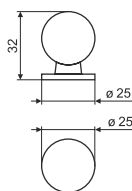

GG17 GG17-G0004

ZnAl

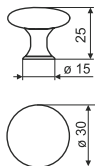

SLIM LINE
GP10 GP10-G0007

ZnAl

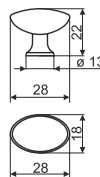

GP09 GP09-G0007

ZnAl

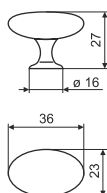

GN67 GN67-G0006

ZnAl

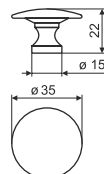

GP51 GP51-G0004
ZnAl

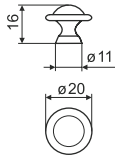

GG29 GG29-G0004
ZnAl

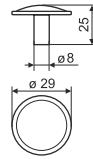

GA05 GA05-G0006
ZnAl

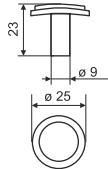

GG09 GG09-G0006
ZnAl

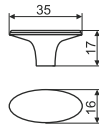

GG28 GG28-G0008
ZnAl

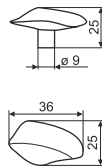

GG13 GG13-G0004
ZnAl

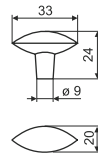



WAVE
GU40 GU40-G0004
ZnAl

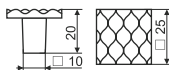

GG43 GG43-G0004
ZnAl

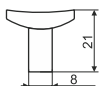

DECOR
GU03 GU03-G0006-L
ZnAl

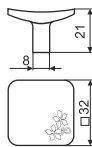

GG07 GG07-G0006
ZnAl

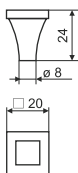

PUENTE
GN04 GN04-G0008
ZnAl

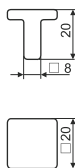

KN04* KN04-G0008
ZnAl

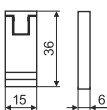

KR04 KR04-0032-G0006
ZnAl

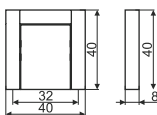

○ — ○ L-32

TESSERE
GW26 GW26-G0005
 ZnAl

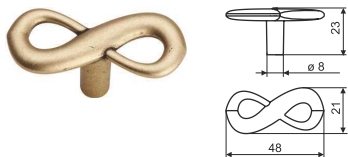

TESSERE CRISTAL
GW26-...-SW GW26-G0035-SW
 ZnAl

made with Crystals from Swarovski®

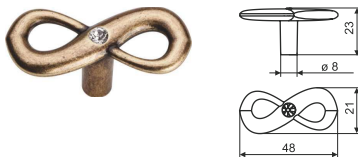

SIPARIO
GW23 GW23-G0031
 ZnAl

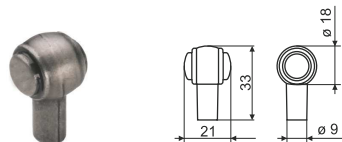

SIPARIO CRISTAL
GW23-...-SW GW23-G0035-SW
 ZnAl

made with Crystals from Swarovski®

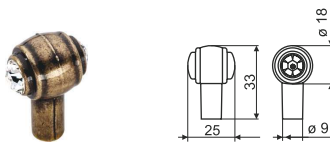

APASIONADO
GR33 GR33-G0005
 ZnAl



UNICO
GR14 GR14-G0005
 ZnAl

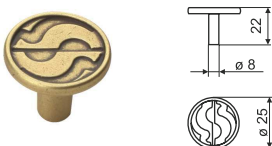

MARITIMO
GR15 GR15-G0005
 ZnAl

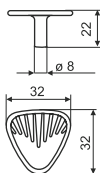

G0005 GA011*



ROTA
GR13 GR13-G0005
 ZnAl

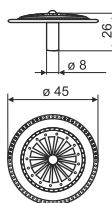

G0005



GR18 GR18-GAE02
 ZnAl

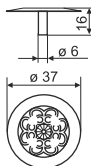

GAE02



GR19 GR19-GAE02
 ZnAl

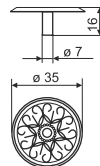

GAE02



GR22 GR22-GAE02
 ZnAl

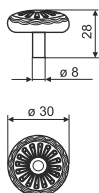

GAE02



GG40 GG40-G0005
 ZnAl

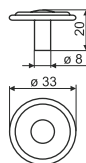

G0005 GA011 G0008*



TENUE
GR24 GR24-GAE02
ZnAl

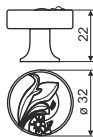

GAE02



GR08 GR08-G0005
ZnAl

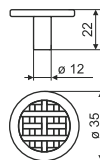

G0005



TRECCIA
GR46 GR46-G0005
ZnAl

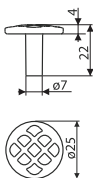

G0005 GAB02 G0035

GA011 G0031 GPM25



GR30 GR30-G0005
ZnAl

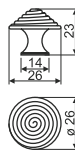

G0005 GA011 GE009*



GR25 GR25-GAE02
ZnAl

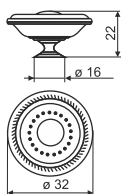

GAE02



100

GS03 GS03-GE009
Stal/ Steel/ Stahl/ Чугун/ Acero/ Acier

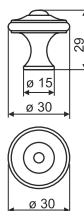

GE009



100

GW01 GW01-G0005
ZnAl

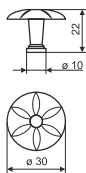

G0005



100

HELIOS
GG16 GG16-G0005
ZnAl

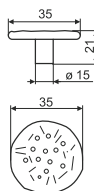

G0005

G0031



100

GA13 GA13-G0005
ZnAl

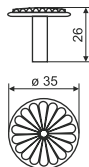

G0002

G0005



100

GA04 GA04-G0002
ZnAl



G0002

G0005



100

CLASSICO
GR41 GR41-G0035
 ZnAl

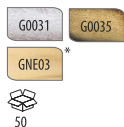
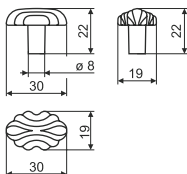

GG12 GG12-G0005
 ZnAl

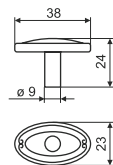

GG31 GG31-G0005
 ZnAl

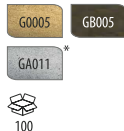
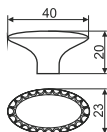

ORIENT
GR03 GR03-G0005
 ZnAl

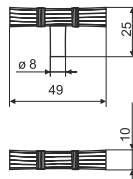

ATENA
GG32 GG32-G0005
 ZnAl

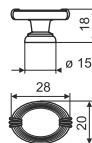

ANGELO
GR36* GR36-G0035
 ZnAl

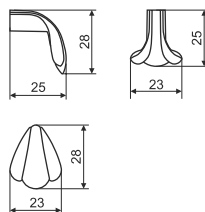

DECOR
GU03 GU03-GAB02-P
ZnAl

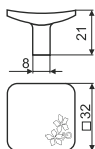

DAFNE
GR10 GR10-G0005
ZnAl

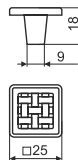

ANTICO
GR37 GR37-G0031
ZnAl

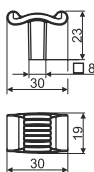

CASTELLO
GR38 GR38-G0031
ZnAl

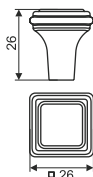

ARUM
GR16 GR16-G0005
ZnAl

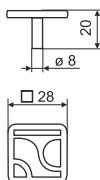

GRECO
GR17 GR17-G0005
ZnAl

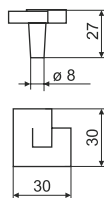

VITREO
GR02 GR02-G0005
ZnAl

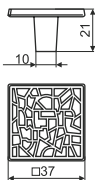

ARCANUM
GR29 GR29-G0005
ZnAl

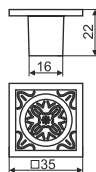

PARK
GU75* GU75-G0005
ZnAl

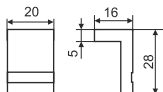

ONDA
GR32 GR32-G0031
 ZnAl



ONDA CRISTAL
GR32-...-SW GR32-G0004-SW
 ZnAl
 made with Crystals from Swarovski®



SORRISO
GW19 GW19-G0035
 ZnAl

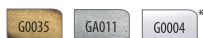

SORRISO CRISTAL
GW19-...-SW GW19-G0004-SW
 ZnAl
 made with Crystals from Swarovski®

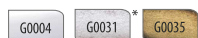

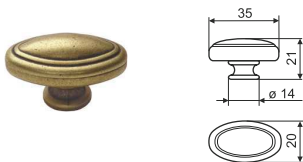

GG42 GG42-G0005
ZnAl



SD07 SD07-G0005  



GG42-G0005 + SD07-G0005



GA11 GA11-GA011
ZnAl

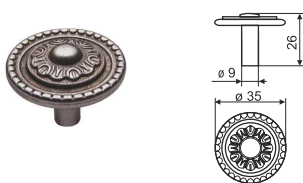

SD02 SD02-GA011  



GA11-GA011 + SD02-GA011



GG36 GG36-G0005
ZnAl

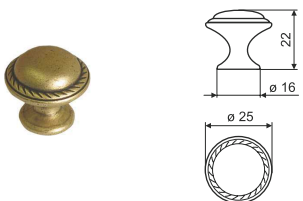

SD36 SD36-G0005  



GG36-G0005 + SD36-G0005



RETICULI
GC01 GC01-GA011
 Sta/ Steel/ Stahl/ Сталь/ Acero/ Acier

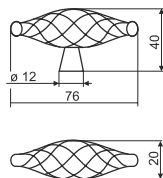

GA011 GAB02



APASIONADO
KR33 KR33-G0005
 ZnAl

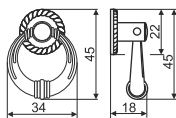

G0005 GA011



CREAVI
KR20 KR20-GAE02
 ZnAl

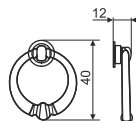

GAE02



KT11 KT11-G0005
 ZnAl

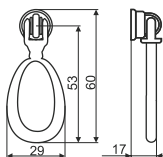

G0004 G0005 GAE02 GC002



RUSTICO
KR21 KR21-GAE02
 ZnAl

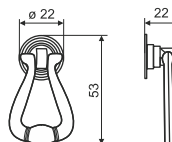

GAE02



KT05 KT05-G0005
ZnAl

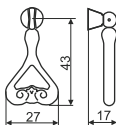

G0005 G0003*



KT04 KT04-G0003
ZnAl

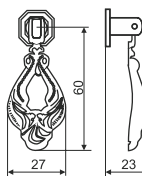

G0001 G0003



KR02 KR02-G0005
ZnAl

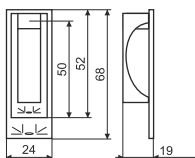

G0005



KT01 KT01-G0003-A
ZnAl

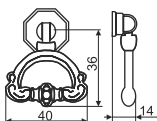

G0001 G0003 G0005



KT09 KT09-G0004
ZnAl

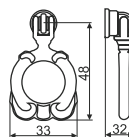

G0001 G0003 G0004 G0006



KR31 KR31-G0005
ZnAl

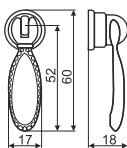

G0005



100

KT07 KT07-G0003
ZnAl

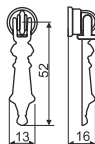

G0005

G0003*



100

KT08 KT08-G0004
ZnAl

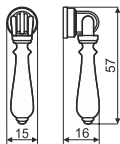

G0004

G0005



100

KT02 KT02-G0005
ZnAl

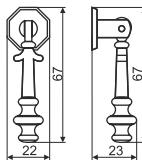

G0005



100

KT03 KT03-G0005
ZnAl

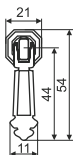

G0002

G0005*



100

SP18 SP18-G00AB

ZnAl

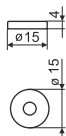
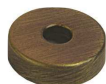

G00AB



ELISA

GP20 GP20-MLK-1

Porcelana/ Porcelain/ Porzellan/ Φαρφορ/ Porcelana/ Porcelaine

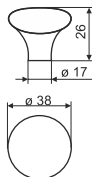

WHT



MLK



VICTORIA

GP19 GP19-GA011-WHT-16

ZnAl

+ Porcelana/ Porcelain/ Porzellan/ Φαρφορ/ Porcelana/ Porcelaine

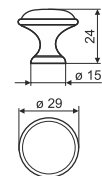

GA011



MLK



0



GA011



WHT

0



G00AB



MLK

0



11



G00AB



WHT

0



SOPHIE

GP18 GP18-MLK-0

Porcelana/ Porcelain/ Porzellan/ Φαρφορ/ Porcelana/ Porcelaine

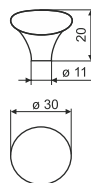

MLK



0



SABINE

GP21 GP21-MLK-3

Porcelana/ Porcelain/ Porzellan/ Φαρφορ/ Porcelana/ Porcelaine

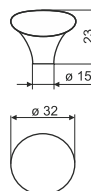

MLK



0



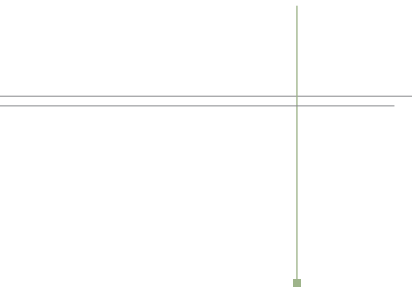

GP03 GP03-GAE02-WHT-5

ZnAl

+ Porcelana/ Porcelain/ Porzellan/ Φαρфор/ Porcelana/ Porcelaine

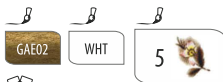
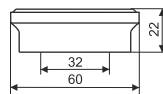

GD44 GD44-D10-F35-M

Drewno/ Wood/ Holz/ Древо/ Madera/ Bois

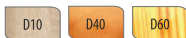
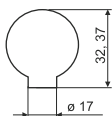

GD41 GD41-D80-M

Drewno/ Wood/ Holz/ Древо/ Madera/ Bois



GD40 GD40-D60-F40-M

Drewno/ Wood/ Holz/ Древо/ Madera/ Bois

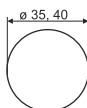
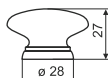

UN30* UN30-0032-G0006-D10

ZnAl

+ Drewno/ Wood/ Holz/ Древо/ Madera/ Bois





SMILE
GU53 GU53-G0004-T

ZnAl
+ Tworzywo/Plastic/ Kunststoff/ Пластика/ Plástico/ Plastique

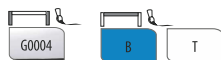
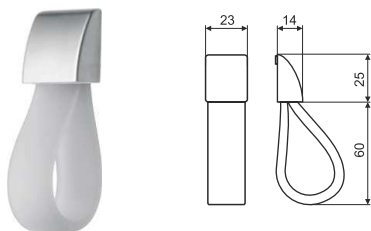

HAPPY FROG
DG05 DG05-R4003

Tworzywo/ Plastic/ Kunststoff/ Пластика/ Plástico/ Plastique

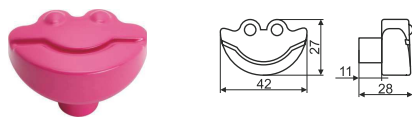

CAMELEON
UU06 UU06-0032-G0004-P51

ZnAl
+ Tworzywo/Plastic/ Kunststoff/ Пластика/ Plástico/ Plastique

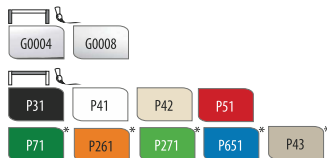
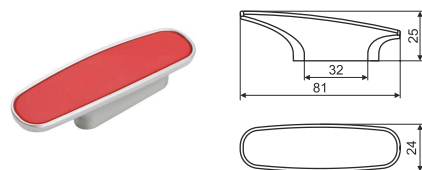

RAINBOW
DG12 DG12-R0027

ZnAl
+ Tworzywo/Plastic/ Kunststoff/ Пластика/ Plástico/ Plastique

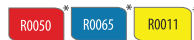
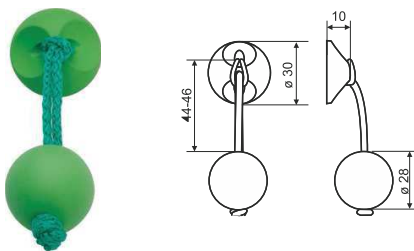

CAMELEON
UU07 UU07-0032-G0008-P271

ZnAl
+ Tworzywo/Plastic/ Kunststoff/ Пластика/ Plástico/ Plastique

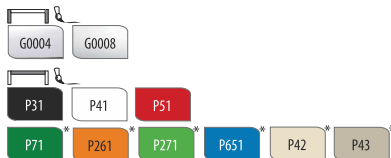
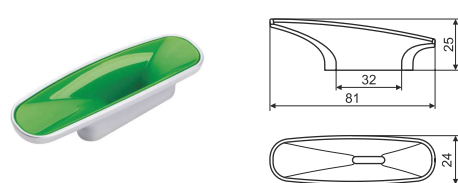



GAMET®



**WIESZAKI
HANGERS
HAKEN
КРЮЧКИ МЕБЕЛЬНЫЕ
COLGADORES
PATÈRES**

DIADEM
RW07 RW07-G0006
ZnAl

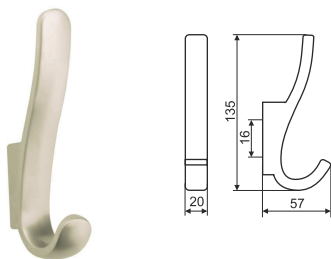

- G0004
- G0006
- G0007
- G0008



WP33 WP33-G0004
ZnAl

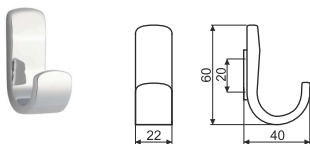

- G0004
- G0007
- G0008
- G0006*



VERSA
WP30 WP30-G0004
ZnAl

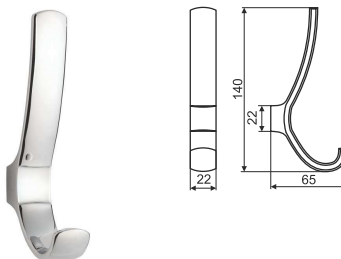

- G0004
- G0006
- G0007
- G0008



QUADRA
RW08 RW08-G0007
ZnAl

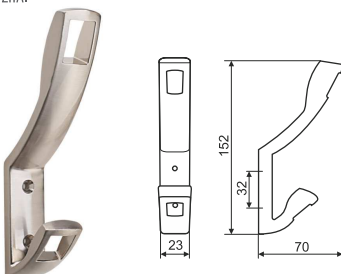

- G0004
 - G0006
 - G0007
 - G0008
-
- 25

WA01 WA01-A0C00
Al

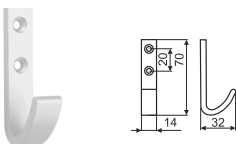

- A0C00
- G0004*



WA02 WA02-A0C00
Al

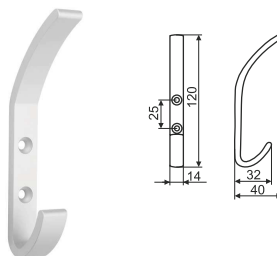

- A0C00
- G0004



WK10 WK10-G0007

ZnAl

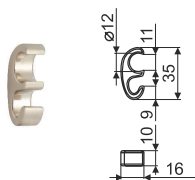

RE10-0160-G0007 + WK10-G0007



MODERNO

WA45 WA45-A0C00-G0004

Al

+ Stal / Steel / Stahl / Сталь / Acero / Acier

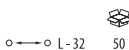
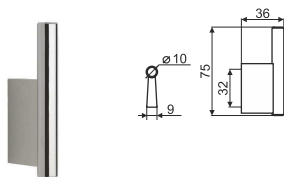

○ → L-32 50

WP01 WP01-G0006-0070-M4

Stal / Steel / Stahl / Сталь / Acero / Acier

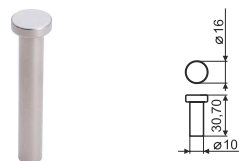

50

RITTO

WP48 WP48-APB35-APB35

Al

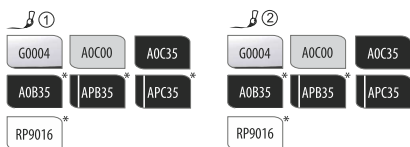

25

SPIRO

WK15 WK15-0016-G0008

ZnAl

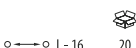
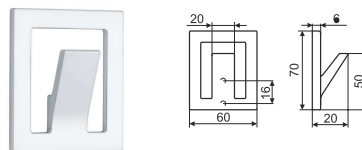

○ → L-16 20

WP14 WP14-G0006

ZnAl

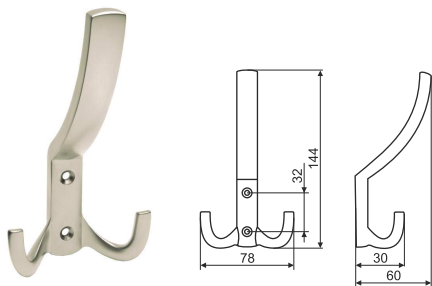

WP13 WP13-G0004

ZnAl

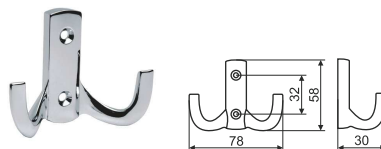

WP11 WP11-G0006

ZnAl

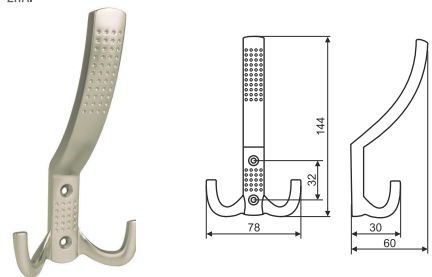

WP12 WP12-G0008

ZnAl

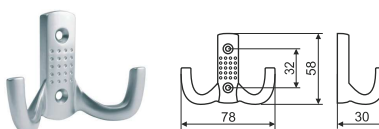

WP05 WP05-G0007

ZnAl

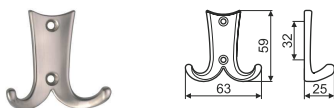

WP25 WP25-G0008

ZnAl



WP07 WP07-G0008
ZnAl

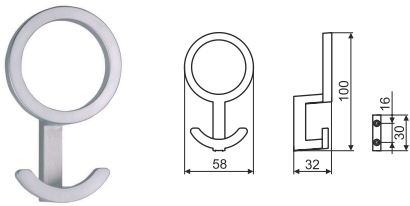

G0006 G0008 G0004* G0007*



WP06 WP06-G0008
ZnAl

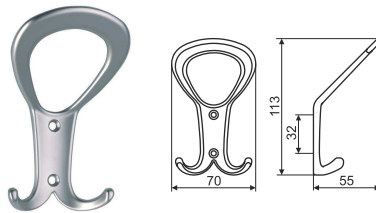

G0007 G0008 G00AB G0004* G0006*



WA09 WA09-0032-G0004-0320
Al

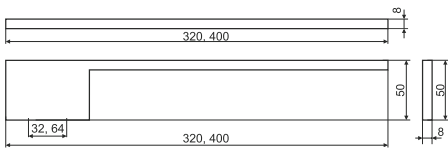

G0004



10 ○ → ○ / □ L - 32/320, 64/400



WP24 WP24-G0006

ZnAl

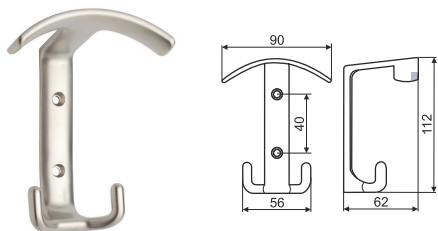

G0006



25

WP10 WP10-G0006

ZnAl

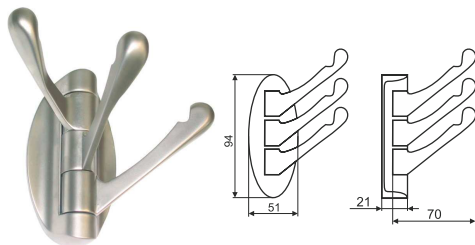

G0004 G0006 G0007 G0008*



10

WP18 WP18-G0035

ZnAl

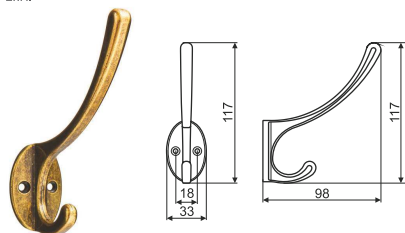

G0004 G0006 G0007 G0008 G0035

G0003* G0005* GA011* GAB02*



50

WP49 WP49-G0004

ZnAl

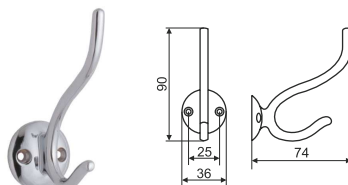

G0004 G0006 G0008 G00AB



25

WP67* WP67-G00AB

ZnAl

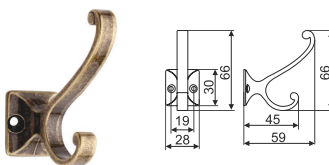

G0004 G0006 G00AB



50

WP68 WP68-G00AB

ZnAl

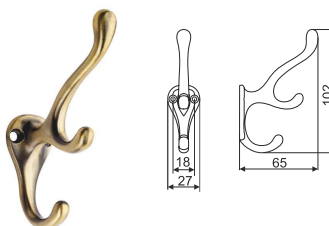

G0004 G00AB G0006*



50

WP71 WP71-G0004
ZnAl

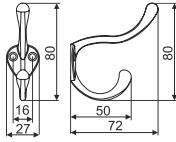

WP59 WP59-G0006
ZnAl

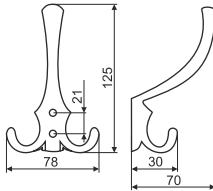

WP60 WP60-G0004
ZnAl

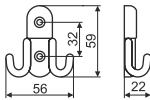

WP65 WP65-G00AB
ZnAl

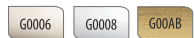
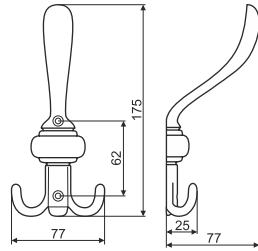

WP89 WP89-G00AB
ZnAl

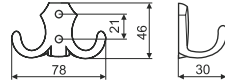

G0003, G0004, G0006, G0008, G00AB - 25
G0005, G0007 - 50

WP19 WP19-G0003

ZnAl

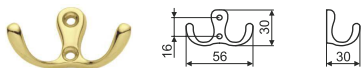

WP39* WP39-G00AB

ZnAl

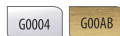
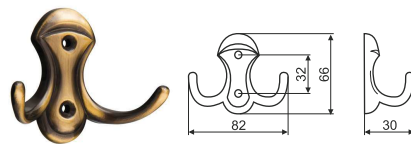

ARCANUM

WR29 WR29-0032-G0005

ZnAl

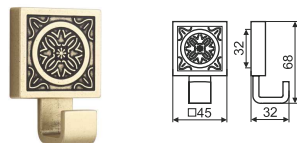

WP99 WP99-G00AB

ZnAl

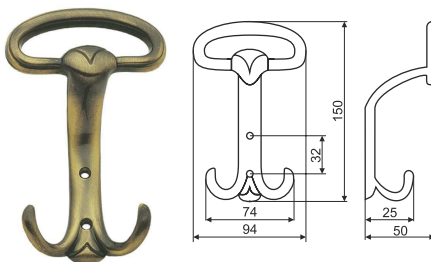

WP93 WP93-G00AB

ZnAl

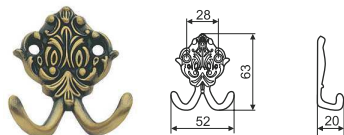

WP92 WP92-G00AB

ZnAl

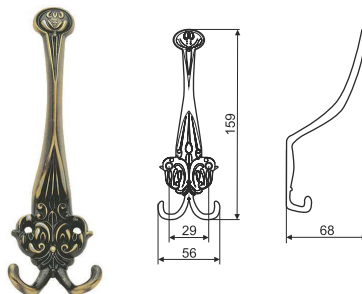

WP69* WP69-G00AB
ZnAl

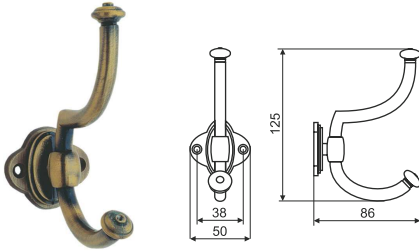

G00AB
10

WP69-...-G WP69-G00AB-G
ZnAl
+ Porcelain/ Porcelain/ Porzellan/ Фарфор/ Porcelana/ Porcelaine

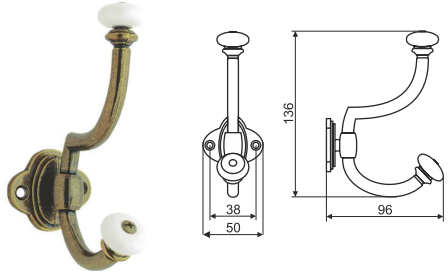

G00AB
10

WK01* WK01-G0001
Stal/Steel/ Stahl/ Сталь/ Acero/ Acier

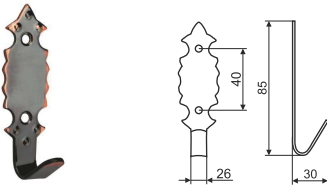

G0001
100

WP29 WP29-G0008
ZnAl

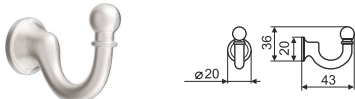

G0003 G0004 G0006 G0008 GAB02
100

WK11 WK11-G0003
ZnAl



G0003 G0004 G0005 G0006
G0007 G0008 R0040*
100

WK12 WK12-G0006
ZnAl



G0003 G0004 G0005 G0006
G0007 G0008 GM003* G0002*
100

WK13 WK13-G0004
ZnAl



G0004 G0006 G0008*
100

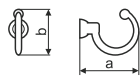

	WK11	WK12	WK13
a	35	44	50
b	27	32	38

CAMELEON

WU06-0032-..., WU07-0032-...

ZnAl

+ Tworzywo / Plastic / Kunststoff / Пластмасса / Plástico / Plastique

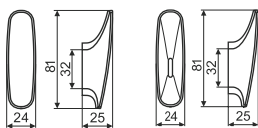

WU06-0032-G0004-P41

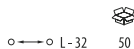
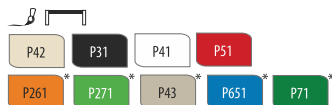

WU07-0032-G0004-P43

Modular
system

Sposób montażu wkładki tworzywowej do stalowej bazy wieszaka WU06 i WU07

How to assemble insert plastic into main metal part of hanger WU06 and WU07 ?

Montage des Kunststoffeinsatzes mit der ZAMAK -Basis der Haken WU06 und WU07

Способ монтажа пластмассовой вставки в металлическое основание крючков WU06 и WU07

El método de montaje del frontal insertable de plástico sobre la base de zamak de los colgadores WU06 y WU07

façon de monter de l'insert en plastique pour la base en ZnAl de la patère WU06 et WU07

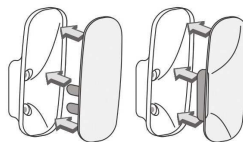

Uwaga!!! Wkładkę można zamontować tylko raz / Attention !!! The insert part can be assembled only once / Achtung! Die Montage des Kunststoffeinsatzes ist nur einmalig möglich / Внимание! Вставку можно монтировать только 1 раз / ¡¡¡Atención!!! El frontal insertable puede montarse sólo una vez / Attention !!! L'insert ne peut être monté qu'une seule fois

Na życzenie klienta możliwe jest przygotowanie indywidualnego koloru wkładki tworzywowej. Minimalna ilość zamówienia to 500 sztuk / Other RAL colours of plastic part on request. MOQ 500 pcs also minimum order quantity 500 pcs / Individuelle Farbe des Kunststoffeinsatzes ist auf Kundenwunsch möglich. Mindestbestellmenge 500 Stück. / По желанию клиента возможно изготовление пластмассовой вкладки в индивидуальном цвете. Минимальное количество - 500 шт / Posibilidad de otros colores en la plástica del tirador: bajo pedido - 500 piezas / Il y a la possibilité d'avoir d'autres couleurs de la partie matière de la poignée - sur commande individuelle - 500 pièces

HAPPY FROGS

DW05 DW05-R0065

Tworzywo / Plastic / Kunststoff / Пластмасса / Plástico / Plastique

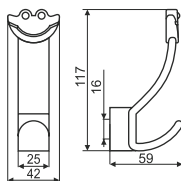

CAMELEON

JEDEN MODEL, WIELE ZASTOSOWAŃ

Modele WU06 i WU07 to oryginalny kształt i bogata kolorystyka, ale także unikalne rozwiązanie techniczne, które sprawia że można je stosować jako:



Uchwyt lub gałka do mebli



Wieszak na drewnianej deseczce



Wieszak do ściany lub kafelki



One model, many opportunities. / WU06 and WU07 models are combination of the original shape and diverse colours, also a unique technical solution that makes it can be used as: handle of knob hanger on wooden board hanger on the wall or tiles, modern handle, many colours unusual shape.

Ein Modell, viele Einsatzmöglichkeiten. / Die Modelle WU06 und WU07 sind eine Kombination aus ursprünglicher Form mit verschiedenen Farben, eine einzigartige technische Lösung die eingesetzt werden kann als Wandhaken, als Haken auf Holzoberfläche oder als Fliesenhaken. Moderner Griff, viele Farben, ungewöhnliche Gestalt.

Одна модель, ряд возможностей по применению. / Модели WU06 и WU07 - это оригинальная форма и богатая цветовая гамма, а также уникальное техническое решение, благодаря которому их можно употреблять как: мебельная ручка или кнопка/крючек на деревянной дощечке/крючек с возможностью прикрепления непосредственно к стене или плитке. Современный дизайн, много цветов, нетипичная форма.

Un modelo, muchas aplicaciones. / Los modelos WU06 y WU07 se caracterizan por una forma original y una riqueza colorística, pero también por ofrecer soluciones técnicas sin igual, lo que hace que puedan ser utilizados como: tirador o pomo para muebles colgador fijado a una tabla de madera colgador fijado a pared o azulejos. Tirador moderno, muchos colores, forma atípica.

Un modèle, plusieurs possibilités. / Modèles WU06 et WU07 associent une forme originale à un très grand choix de couleurs et aux solutions techniques uniques. Ils peuvent être utilisés comme: poignée ou pommeau pour meubles patère sur un petit panneau en bois patère murale ou pour carrelage. Poignée moderne, nombreuses couleurs, forme atypique.

WP04* WP04-MW601D

Stal/Steel/Stahl/Сталь/Acero/Acier

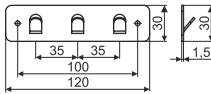

25

WD525-15 WD525-15-G0004

ZnAl

+ Drewno / Wood / Holz / Дерево / Madera / Bois



1

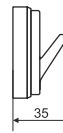
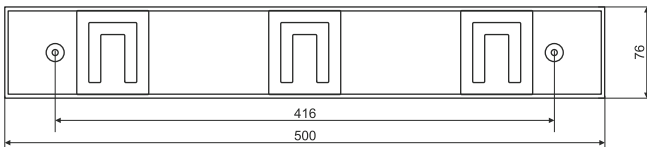

WD691-14 WD691-14-G0006

ZnAl

+ Drewno / Wood / Holz / Дерево / Madera / Bois



1

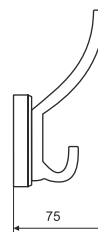
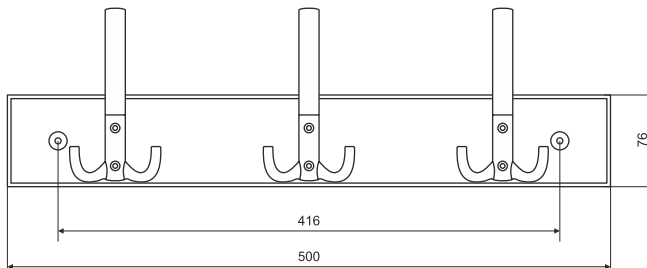

WD13-89 WD13-89-G0006

ZnAl

+Drewno / Wood / Holz / Дерево / Madera / Bois



G0006 G0003*

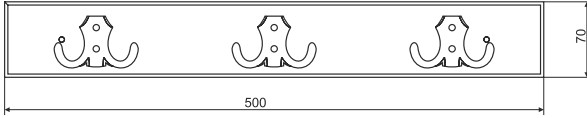

WD13-59 WD13-59-G0006

ZnAl

+Drewno / Wood / Holz / Дерево / Madera / Bois



G0006

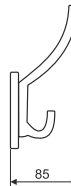
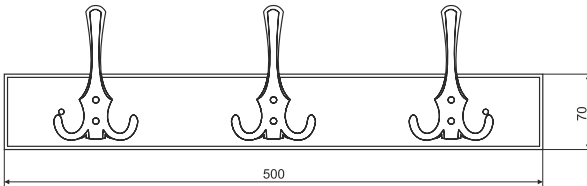

WD791-07 WD791-07-G0006

ZnAl

+Drewno / Wood / Holz / Дерево / Madera / Bois



G0006

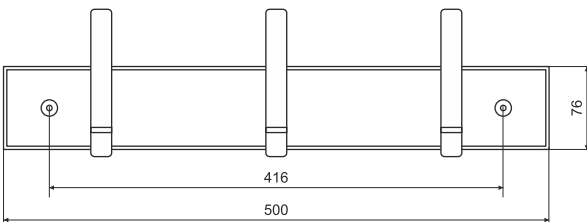

WD28-92 WD28-92-G00AB

ZnAl

+ Drewno / Wood / Holz / Дерево / Madera / Bois

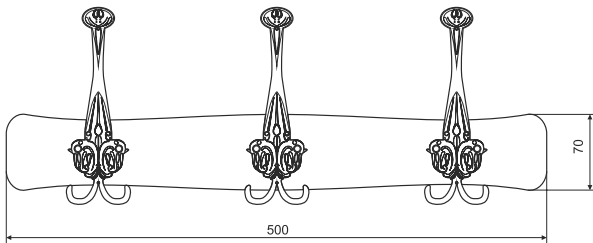

G00AB

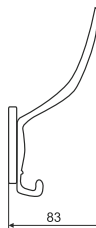

WD28-59 WD28-59-G00AB

ZnAl

+ Drewno / Wood / Holz / Дерево / Madera / Bois

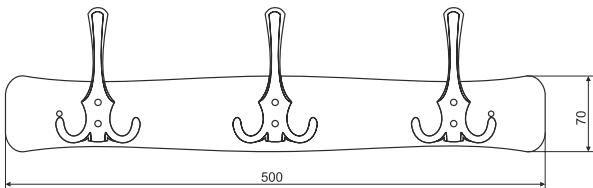

G0003

G0006

G00AB

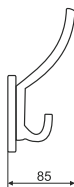

WD940* WD940-0500-DW05-27-3

Drewno / Wood / Holz / Дерево / Madera / Bois
 +Tworzywo / Plastic / Kunststoff /
 Пластмасса / Plástico / Plastique



R0027

R4003

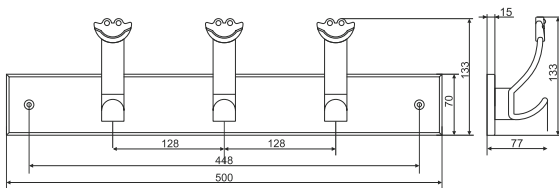
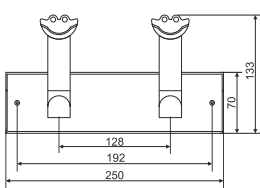
**WD840*** WD840-0250-40-2

Drewno / Wood / Holz / Дерево / Madera / Bois

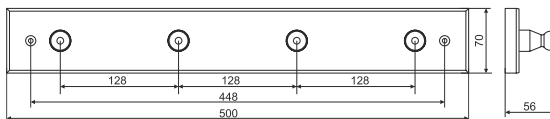
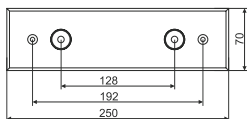

R0040

**WD865*** WD865-0500-40-65-40-65-4

Drewno / Wood / Holz / Дерево / Madera / Bois



R0065

R0040

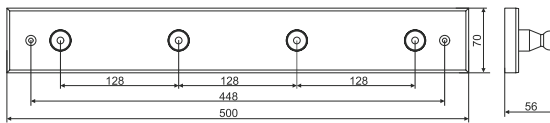
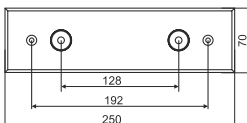

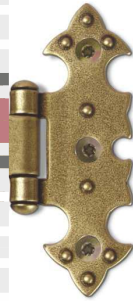
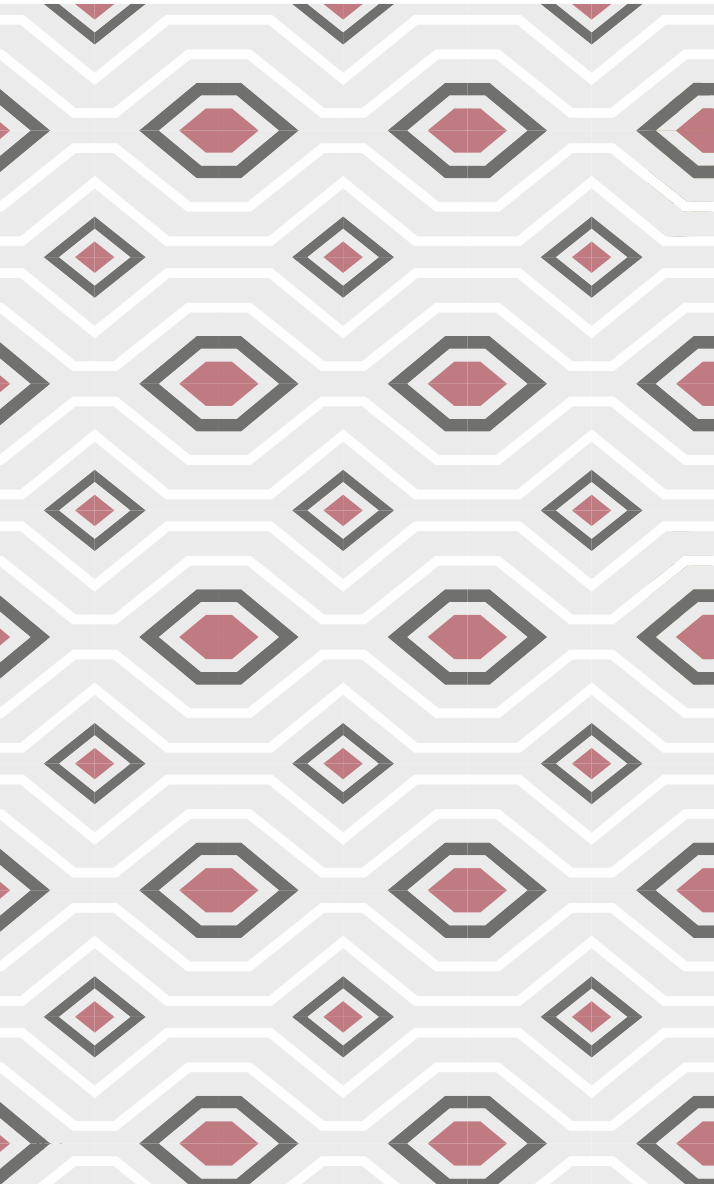

**KLUCZE, SZYLDY, ZAWIASY
KEYS, BACKPLATES, HINGES
SCHLÜSSEL, SCHILDER, SCHARNIERE
КЛЮЧИ, НАКЛАДКИ, ПЕТЛИ
LLAVES, PLACAS, BISAGRAS
CLEFS, PLAQUES DE PROPRETÉ, CHARNIÈRES**



SD02 SD02-G0005
ZnAl

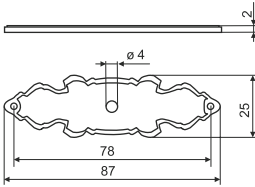

SD36 SD36-G0005
ZnAl

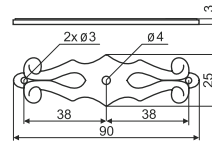

SD51 SD51-G0005
ZnAl

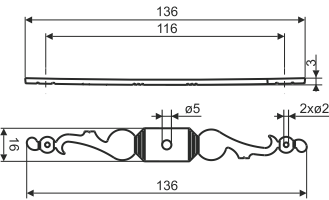

SD04* SD04-G0005
ZnAl

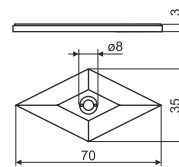

SD07 SD07-G0005
ZnAl

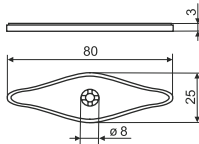

SD09 SD09-G0006
ZnAl

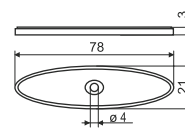

KL01 KL01-G0004

ZnAl

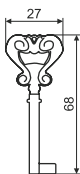

KL04 KL04-G0001

ZnAl

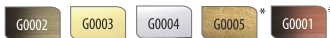
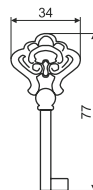

KL02 KL02-G0003

ZnAl

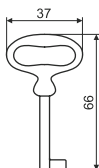

KL03 KL03-G0005

ZnAl

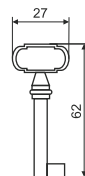

SD25* SD25-G0003

ZnAl

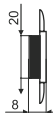
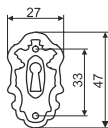

SD27 SD27-G0005

ZnAl

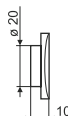

ZS01 ZS01-G0005
Stal/ Steel/ Stahl/ Сталь/ Acero/ Acier

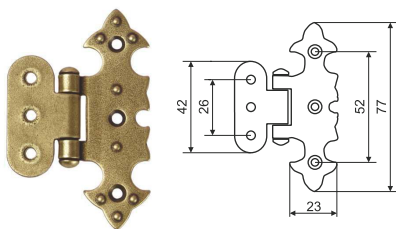

G0003 G0005



100

ZS10 ZS10-G0005-L-ZN
ZnAl

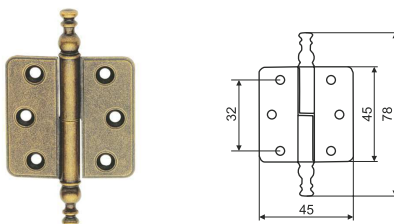

G0002 G0004 G0005 GA005
GA011 G0035 G0003*



50

ZS90 ZS90-G0004
Stal/ Steel/ Stahl/ Сталь/ Acero/ Acier
+ Tworzywo/Plastic/ Kunststoff/ Пластмасса/ Plástico/ Plastique

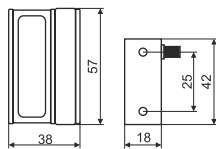

G0004 G0006 G0008



50

UCH30-G0004 + EL-ZS90-G0004-ZS





GAMET®



NÓŽKI

LEGS

FÜßE

НОЖКИ МЕБЕЛЬНЫЕ

PATAS

PIEDS

NZ55* NZ55-G00AB

ZnAl

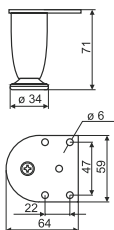

G0004 G00AB



20

NZ09 NZ09-G0004-U

ZnAl

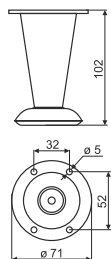

G0004 G0006 G0003*



24

NS25* NS25-G0004-120

Stal / Steel / Stahl / Crany / Acero / Acier

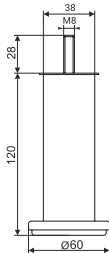

G0004

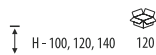

H - 100, 120, 140

120

NZ47 NZ47-G0008-100

ZnAl

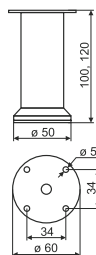

G0008

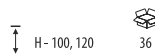

H - 100, 120

36

NS51* NS51-0100-G0004

Stal / Steel / Stahl / Crany / Acero / Acier

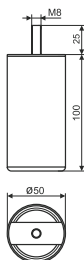

G0004

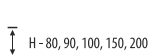

H - 80, 90, 100, 150, 200



30



NS69 NS69-0220-G0004-F40

Stal / Steel / Stahl / Сталь / Acero / Acier

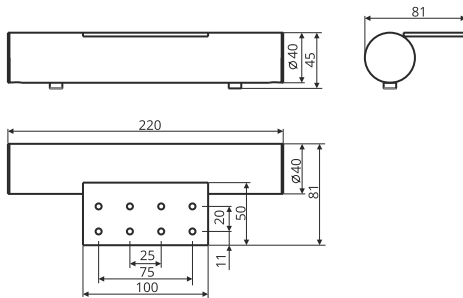

G0004



25

NS70 NS70-0220-G0004-F50

Stal / Steel / Stahl / Сталь / Acero / Acier

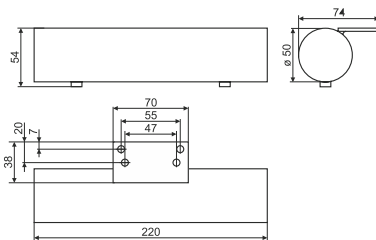

G0004



25

NS22* NS22-0170-G0004-F32

Stal / Steel / Stahl / Сталь / Acero / Acier

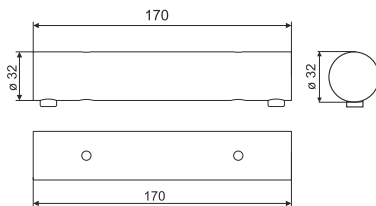

G0004



70

NS24* NS24-0150-G0004-F50

Stal / Steel / Stahl / Сталь / Acero / Acier

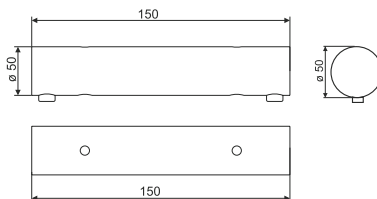

G0004



NS61 NS61-G0004

Stal / Steel / Stahl / Сталь / Acero / Acier

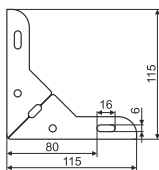

G0004



NS72 NS72-G0004

Stal / Steel / Stahl / Сталь / Acero / Acier

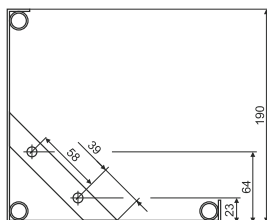

G0004



NS26* NS26-0135-G0004
 Stal / Steel / Stahl / Сталь / Acero / Acier



G0004



H- 100, 135 50

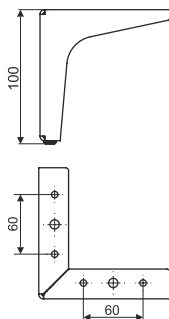

NZ50 NZ50-G0004
 ZnAl



G0004



24

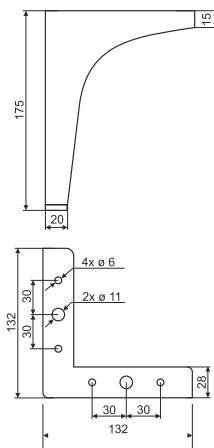

NZ59* NZ59-G0004-100
 Stal / Steel / Stahl / Сталь / Acero / Acier



G0004



24

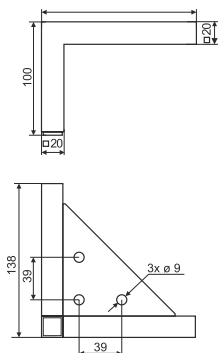

NZ15* NZ15-RSM08

ZnAl

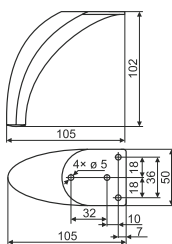

RSM08



20

NA33* NA33-0150-AEC00

Al

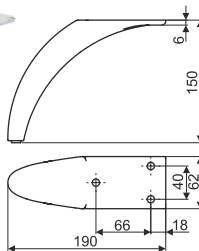

AEC00



20

NS02 NS02-0090-G0004

Stal / Steel / Stahl / Сталь / Acero / Acier

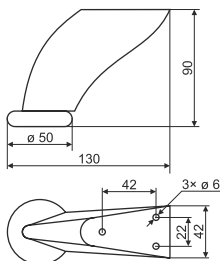

G0004



50

NZ07* NZ07-G0004

ZnAl

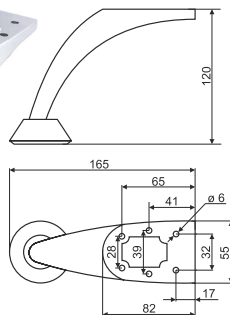

G0004



24

NZ18* NZ18-G0004-N

ZnAl

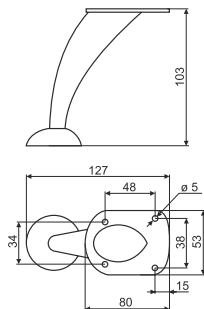

G0004



48

NZ30 NZ30-G0004
ZnAl

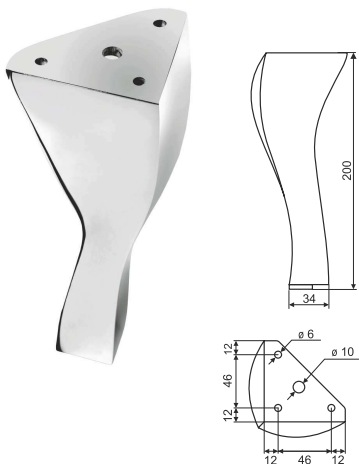

G0004



NA32* NA32-0150-AEC00
Al

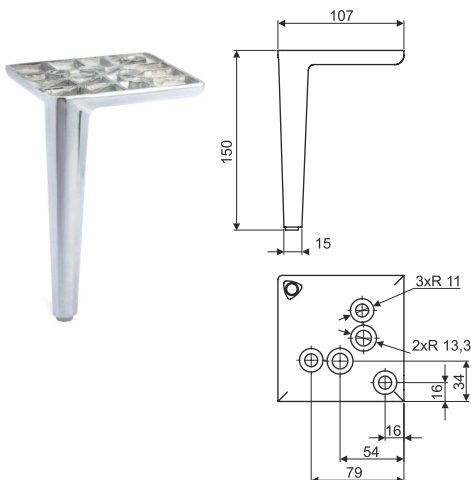

AEC00



NA105 NA105-0120-A0C00-A0000
Al

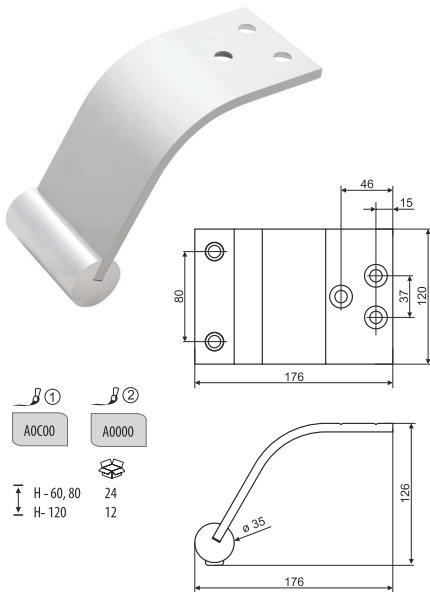

① A0C00 ② A0000

H - 60, 80 24
H - 120 12

NA20 NA20-0100-A0C00

Al

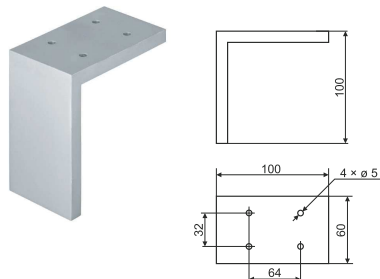

G0004 A0C00



NA20-R NA20-0100-A0C00-R

Al

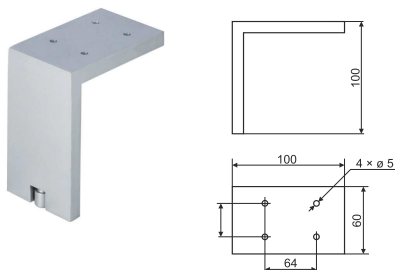

A0C00 G0004*



R - z możliwością regulacji +4 mm ::
with adjustable +4 mm :: mit einstellbarer
Höhe +4 mm :: с регулировкой +4 mm
:: regulable +4 mm :: réglable +4 mm

NA02 NA02-0120-A0C00

Al

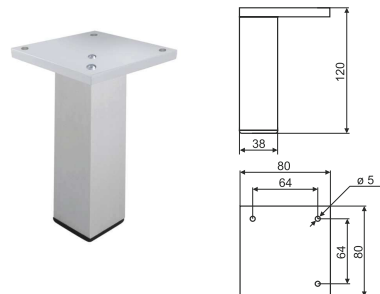

A0C00 AEC00

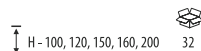

PN06 PN06-120-P0008

Tworzywo / Plastic / Kunststoff / Пластика / Plástico / Plastique

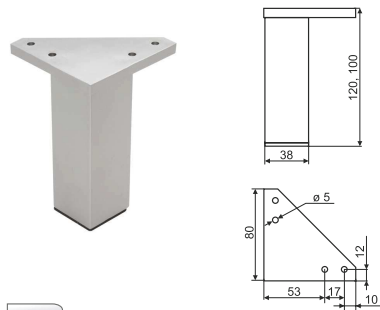

P0008

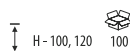

PN15 PN15-RSM08

Tworzywo / Plastic / Kunststoff / Пластика / Plástico / Plastique

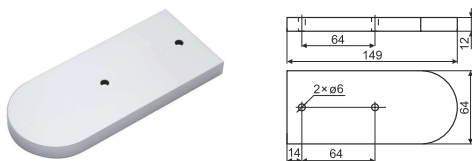

RSM08



NA03 NA03-0120-A0C00-R
AI

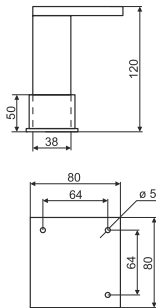

AEC00 AOC00



H - 100, 120, 150, 200, 250, 270

28

NA01* NA01-0120-A0C00
AI

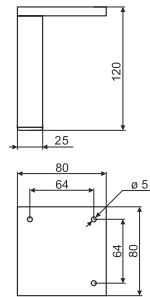

AOC00



H - 100, 120, 150, 160

32

NA50 NA50-0100-A0C00
AI



AOC00



H - 100

50

NA50-R* NA50-0100-A0C00-R
AI



AOC00



H - 100

50

R - z możliwością regulacji +10 mm :: with adjustable +10 mm :: mit einstellbarer Höhe +10 mm :: с регулировкой +10 mm :: regulable +10 mm :: réglable +10 mm

NA04 NA04-0120-AEC00
AI

+ Tworzywo / Plastic / Kunststoff / Пластмасса / Plástico / Plastique

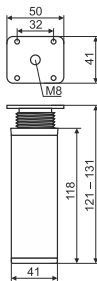

AEC00



H - 100, 120, 270

100

NA12 NA12-0100-A0C00-R
AI

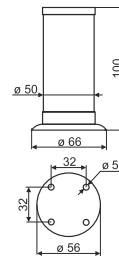

AOC00



H - 100, 120, 150, 180

20

R - z możliwością regulacji +8 mm :: with adjustable +8 mm :: mit einstellbarer Höhe +8 mm :: с регулировкой +8 mm :: regulable +8 mm :: réglable +8 mm

NA11-R NA11-0150-A0C00-R

Al

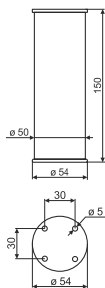

A0C00



H - 50, 60, 70, 80, 100, 120, 150, 180

24

NA11-R-N NA11-0100-A0C00-R-N

Al

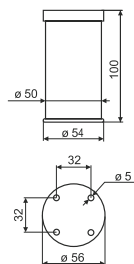

A0C00

G0004



H - 100, 120, 150

24

NA10-R NA10-0100-G0004-R

Al

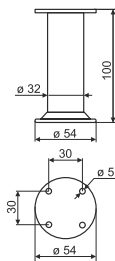

A0C00

G0004*



H - 70, 100, 120, 150, 180

24

NA10-R-N NA10-0150-A0C00-R-N

Al

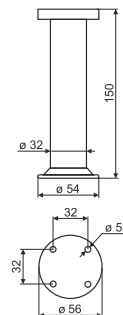

A0C00

G0004*



H - 70, 100, 120, 150, 180

24

R - z możliwością regulacji +10 mm z podstawą górną TS17 :: with adjustable +10 mm, stand top TS17 :: mit einstellbarer Höhe +10 mm :: с регулировкой +10 mm, верхняя накладка TS17 :: regulable +10 mm, s :: orrote para la TS17 :: réglable +10 mm par rapport à la base supérieure, Pied de TS17

R-N - z możliwością regulacji +10 mm z podstawą górną TS17 :: with adjustable +10 mm, stand top TS17 :: mit einstellbarer Höhe +10 mm :: с регулировкой +10 mm, верхняя накладка TS17 :: regulable +10 mm, s :: orrote para la TS17 :: réglable +10 mm par rapport à la base supérieure, Pied de TS17

NA15 NA15-0080-AEC00-P40-R

AI

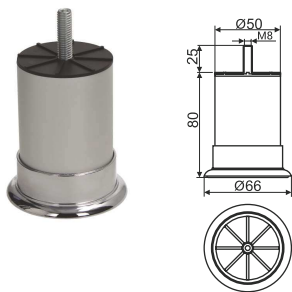

PN03* PN03-P0004-S

Tworzywo / Plastic / Kunststoff / Пластмасса / Plástico / Plastique



PN16 PN16-0150-P30-KLIP

Tworzywo / Plastic / Kunststoff / Пластмасса / Plástico / Plastique

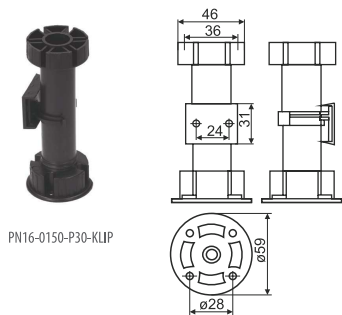

PN16-0150-P30-KLIP

PN01 PN01-P0006-P30

Tworzywo / Plastic / Kunststoff / Пластмасса / Plástico / Plastique

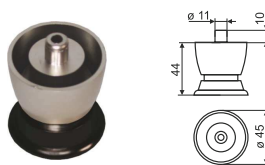

PN57 PN57-0100-PWM08-R

Tworzywo / Plastic / Kunststoff / Пластмасса / Plástico / Plastique

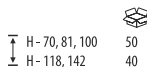
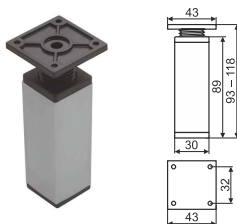

PN16 PN16-0150-P30

Tworzywo / Plastic / Kunststoff / Пластмасса / Plástico / Plastique



PN16-0150-P30

PN16-KLIP-P30

PN16



PN16-KLIP



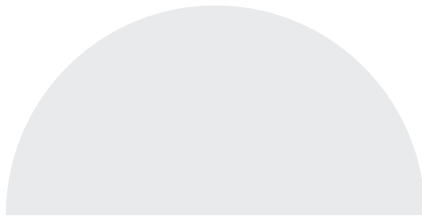

INNE :: OTHER ACCESSORIES :: SONSTIGE :: ДРУГИЕ :: OTROS :: AUTRES

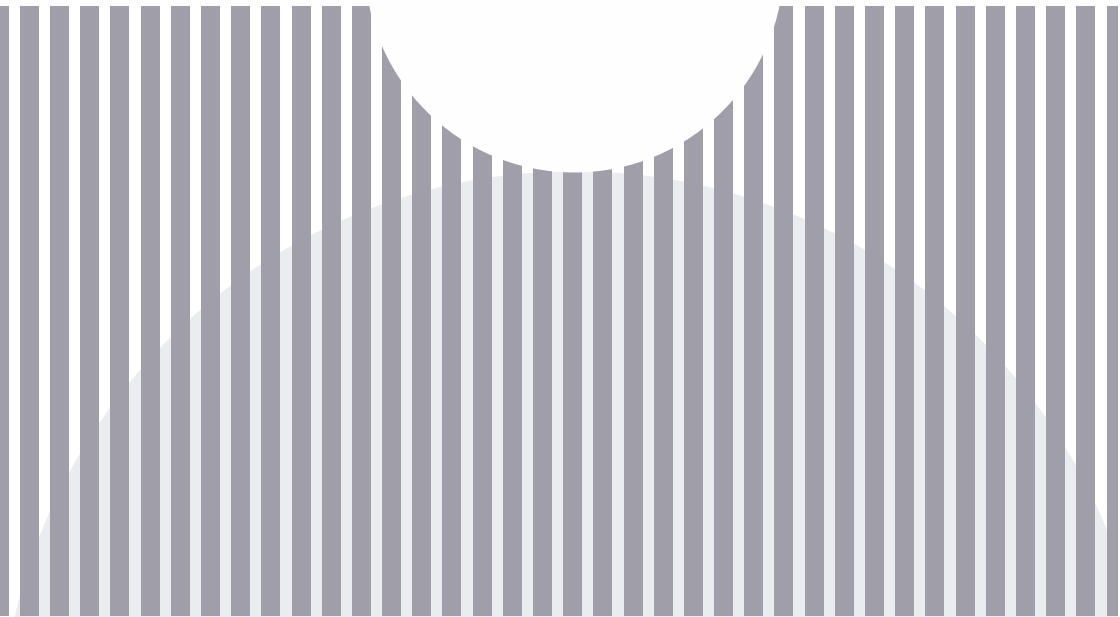

Mocowanie półek :: Shelf supports :: Bodenträger :: Крепления для полок :: Fijación de estantes :: Fixation d'étagères

MP01 MP01-G0004
ZnAl

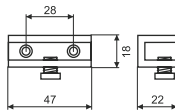

do szyb max 6 mm / for glass max 6 mm
für Glasboden max 6 mm stark / для стекла макс. 6 мм
fijación al cristal máx. 6 mm / pour verre de 6 mm max



MP02 MP02-G0004
ZnAl

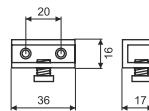

do szyb max 6 mm / for glass max 6 mm
für Glasboden max 6 mm stark / для стекла макс. 6 мм
fijación al cristal máx. 6 mm / pour verre de 6 mm max



MP40 MP40-G0004
ZnAl

+ Stal/ Steel/ Stahl/ Сталь / Acero/ Acier

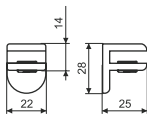

do szyb max 6 mm / for glass max 6 mm
für Glasboden max 6 mm stark / для стекла макс. 6 мм
fijación al cristal máx. 6 mm / pour verre de 6 mm max



MP50 MP50-G0004
ZnAl

+ Stal/ Steel/ Stahl/ Сталь / Acero/ Acier

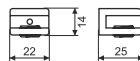

do szyb max 6 mm / for glass max 6 mm
für Glasboden max 6 mm stark / для стекла макс. 6 мм
fijación al cristal máx. 6 mm / pour verre de 6 mm max



AD01 AD01-G0004
ZnAl

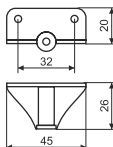

System relingowy :: Kitchen railing system Relingsysteme :: Система кухонных релингов Sistema modular de barandillas :: Système de relings

RP01 RP01-G0004
ZnAl



RP02 RP02-G0004
ZnAl



RP10 RP10-G0004
ZnAl



RP11 RP11-G0004
ZnAl

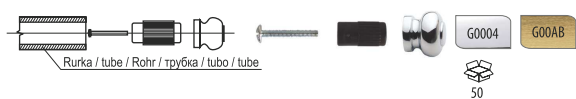

RP40* RP40-R0030
Tworzywo / Plastic / Kunststoff / Пластмасса / Plástico / Plastique

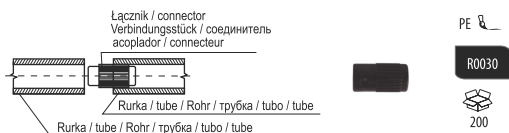



RP50* RP50-G0004

Stal / Steel / Stahl / Сталь / Acero / Acier



G0004 G0008



RP51* RP51-G0004

Stal / Steel / Stahl / Сталь / Acero / Acier



G0004



RP60 RP60-1000-G0004

Stal / Steel / Stahl / Сталь / Acero / Acier



G0004 G0006* G0008* G00AB*



RP30 RP30-G0004

Stal / Steel / Stahl / Сталь / Acero / Acier



G0004 G0008 G00AB

G0006*



ODB-02 ODB-02

Odbojnik drzewiowy / Door bumper /
Frontpuffer / Демпфер самоклеющийся /
Tope de puerta / Pastille adhesive



TU01 TU01

Tulejka dystansowa do szyby / Distance sleeve for glass /
Gummi-Muffe / Пластмассовая втулка для стекла /
Casquillo distanciador para cristal / Douille d'écartement pour vitre

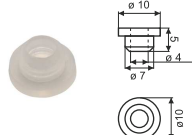

jeden kpl. RP30 zawiera 5 szt. / 1 kit includes 5 pieces
1 Set besteht aus 5 Stück / 1 комплект состоит из 5 шт.
Un paquete incluye 5 unidades / Un jeu contient 5 pc.

Symbol Code Symbol Индекс Simbolo Code	Nr strony Page number Seite № страници №º de pàgina Page nº	Symbol Code Symbol Индекс Simbolo Code	Nr strony Page number Seite № страници №º de pàgina Page nº	Symbol Code Symbol Индекс Simbolo Code	Nr strony Page number Seite № страници №º de pàgina Page nº
A					
AD01	221	GL08	163	GR41	24, 134, 174
D					
DG05	152, 185	GL10	162	GR46	14, 129, 172
DG12	152, 185	GL12	162	GS02	164
DG13	152	GL46	91, 162	GS03	173
DU05	152	GL66-1	85, 156	GS05	163
DW05	152, 196	GN01	163	GS06	163
G					
GA04	173	GN04	109, 169	GS16	99, 160
GA05	167	GN06	160	GS24	97, 157
GA08	165	GN07	160	GS48	85, 156
GA09	77, 165	GN10	165	GS91	76, 104, 159
GA11	178	GN32	166	GS92	97, 157
GA13	173	GN34	166	GU03	142, 168, 175
GA27	163	GN67	166	GU22	157
GA28	164	GN68	160	GU30	95, 156
GC01	145, 179	GP03	149, 183	GU40	105, 168
GD40	183	GP09	166	GU53	153, 185
GD41	183	GP10	166	GU54	162
GD44	183	GP11	165	GU56	165
GG01	164	GP16	165	GU75	143, 176
GG02	98, 157	GP18	182	GW01	173
GG06	159	GP19	38, 147, 182	GW19	133, 177
GG07	169	GP20	148, 182	GW19-...-SW	133, 177
GG09	167	GP21	148, 182	GW23	44, 92, 136, 170
GG10	164	GP51	167	GW23-...-SW	44, 92, 136, 170
GG12	174	GR02	143, 176	GW26	132, 170
GG13	167	GR03	145, 174	GW26-...-SW	132, 170
GG16	144, 173	GR08	172	K	
GG17	166	GR10	144, 175	KL01	206
GG21	157	GR13	171	KL02	206
GG23	160	GR14	170	KL03	206
GG28	167	GR15	135, 171	KL04	206
GG29	167	GR16	137, 176	KN04	169
GG31	174	GR17	176	KN98	141
GG32	138, 174	GR18	171	KR02	180
GG36	178	GR19	171	KR04	169
GG39	109, 159	GR22	171	KR07	141
GG40	171	GR24	137, 172	KR08	141
GG42	178	GR25	173	KR13	141
GG43	77, 168	GR27	105, 157	KR20	137, 179
GG44	109, 159	GR29	142, 176	KR21	139, 179
GG45	164	GR30	172	KR31	181
GG50	164	GR32	10, 131, 177	KR33	139, 179
GL02	163	GR32-...-SW	12, 131, 177	KT01	180
		GR33	139, 170	KT02	181
		GR36	22, 133, 174	KT03	140, 181
		GR37	134, 175	KT04	180
		GR38	135, 175	KT05	140, 180

Symbol Code Symbol Индекс Simbolo Code	Nr strony Page number Seite Nº страници Nº de pàgina Page nº
KT07	181
KT08	181
KT09	180
KT11	179
M	
MD01	124
MD02	124
MD03	124
MD04	123
MD11	123
MD12	124
MD13	124
MD14	122
MD61	124
MP01	221
MP02	221
MP40	221
MP50	221
N	
NA01	217
NA02	216
NA03	217
NA04	217
NA10S	215
NA10-R	218
NA10-R-N	218
NA11-R	218
NA11-R-N	218
NA12	217
NA15	219
NA20	216
NA20-R	216
NA32	215
NA33	214
NA50	217
NA50-R	217
NS02	214
NS22	211
NS24	212
NS25	210
NS26	213
NS51	210
NS61	212
NS69	211
NS70	211

Symbol Code Symbol Индекс Simbolo Code	Nr strony Page number Seite Nº страници Nº de pàgina Page nº
NS72	212
NZ07	214
NZ09	210
NZ15	214
NZ18	214
NZ30	215
NZ47	210
NZ50	213
NZ55	210
NZ59	213
O	
ODB-02	223
P	
PA-UA93	70, 119
PA-UA94	70, 119
PA-UA96	70, 119
PN01	219
PN03	219
PN06	216
PN15	216
PN16	219
PN57	219
R	
RE07	86
RE10	76, 93
RE11	93
RE16	94
RE18	86
RE21	87
RE23	44, 92, 136
RE23-...-SW	44, 92, 136
RE28	60, 86
RE50	87
RE81	94
RE82	94
RE90	93
RG08	98, 159
RP01	222
RP02	222
RP10	222
RP11	222
RP30	223
RP40	222
RP50	223
RP51	223

Symbol Code Symbol Индекс Simbolo Code	Nr strony Page number Seite Nº страници Nº de pàgina Page nº
RP60	223
RR08	98
RU05	86
RU08	84
RU09	84
RU20	94
RW07	188
RW08	98, 188
S	
SD02	178, 205
SD04	205
SD07	178, 205
SD09	205
SD25	206
SD27	206
SD36	178, 205
SD51	205
SP18	182
T	
TU01	223
U	
UA01	122
UA02	100
UA06	94
UA08	123
UA09	87
UA10	97
UA12	100
UA15	101
UA45	121
UA46	91
UA47	91
UA48	91
UA51	89
UA53	89
UA54	100
UA55	87
UA57	121
UA58	122
UA59	62, 96
UA63	100
UA66	85
UA67	83
UA67-...-ZN	83
UA68	121
UA68-...-R10	121

Symbol Code Symbol Индекс Simbolo Code	Nr strony Page number Seite Nº страници Nº de pàgina Page nº	Symbol Code Symbol Индекс Simbolo Code	Nr strony Page number Seite Nº страници Nº de pàgina Page nº	Symbol Code Symbol Индекс Simbolo Code	Nr strony Page number Seite Nº страници Nº de pàgina Page nº
UA76	58, 90	UN36	111	UR10	138
UA77	58, 90	UN37	116	UR11	141
UA78	58, 90	UN38	110	UR15	135
UA79	100	UN40	112	UR16	137
UA81	101	UN42	103	UR19	133
UA82	58, 90	UN43	112	UR19...-SW	133
UA84	84	UN45	103	UR20	137
UA85	83	UN48	104	UR21	139
UA86	118	UN49	98	UR22	143
UA87	118	UN50	123	UR24	137
UA88	118	UN51	111	UR25	8, 129
UA89	101	UN54	116	UR26	132
UA91	54, 106	UN62	110	UR26...-SW	132
UA92	68, 117	UN63	122	UR27	105
UA110	117	UN71	88	UR28	110
UC01	145	UN73	87	UR29	142
UD23	125	UN77	102	UR32	10, 131
UD24	125	UN80	108	UR32...-SW	12, 131
UD25	125	UN81	108	UR33	139
UF19	125	UN83	114	UR36	22, 133
UF89	125	UN87	105	UR37	134
UG09	100	UN88	115	UR38	135
UG17	144	UN89	110	UR40	16, 130
UG19	144	UN90	76, 116	UR40...-SW	18, 130
UG20	98	UN91	114	UR41	24, 134
UG30	144	UN92	104	UR42	20, 135
UG32	138	UN94	103	UR43	26, 143
UG38	115	UN96	111	UR44	28, 134
UG39	109	UN97	111	UR45	30, 134
UG41	105	UP01	141	UR46	14, 129
UG43	103	UP03	149	US01	140
UG44	109	UP10	115	US03	140
UN01	102	UP11	34, 141	US05	114
UN03	142	UP16	36, 149	US09	115
UN04	109	UP17	38, 147	US10	76, 112
UN06	108	UP19	147	US12	66, 120, 153
UN07	112	UP20	148	US14	110
UN10	159	UP21	148	US15	99
UN13	111	UP38	112	US16	106
UN14	111	UP81	113	US21	99
UN17	77, 116	UP82	113	US24	114
UN18	116	UP83	113	US26	114
UN26	102	UP84	113	US27	114
UN29	102	UP85	113	US28	138
UN30	183	UR03	145	US29	110
UN31	32, 138	UR05	145	US48	85
UN34	88	UR07	138	US62	125
UN35	108	UR09	143	US81	127

Symbol
Code
Symbol
Индекс
Simbolo
Code

Nr strony
Page number
Seite
Nº страници
Nº de pàgina
Page nº

Symbol
Code
Symbol
Индекс
Simbolo
Code

Nr strony
Page number
Seite
Nº страници
Nº de pàgina
Page nº

Symbol
Code
Symbol
Индекс
Simbolo
Code

Nr strony
Page number
Seite
Nº страници
Nº de pàgina
Page nº

US91	76, 104
US92	97
UT43	103
UU03	50, 106
UU04	96
UU05	56, 88
UU06	82, 151, 156, 185
UU07	82, 151, 156, 185
UU09	108
UU10	104
UU13	52, 106
UU15	40, 42, 80, 81, 136
UU16	48, 106
UU24	97
UU25	96
UU27	97
UU30	95
UU37	115
UU40	105
UU42	102
UU53	153
UU67	88
UU68	94
UU69	88
UU74	102
UU75	143
UU78	140
UX02	126
UX03	126
UX04	126
UX05	126
UX11	126
UX12	127
UX82	127
UX87	127
UZ25	96
UZ94	77, 103

W

WA01	188
WA02	188
WA09	64, 191
WA45	91, 189
WD13-59	199
WD13-89	199
WD28-59	200
WD28-92	200
WDS25-15	198

WD691-14	198
WD791-07	199
WD840	201
WD865	201
WD940	201
WG	46
WK01	195
WK10	92, 189
WK11	195
WK12	195
WK13	195
WK15	99, 189
WP01	189
WP04	198
WP05	190
WP06	191
WP07	191
WP10	192
WP11	190
WP12	190
WP13	190
WP14	190
WP18	192
WP19	194
WP24	192
WP25	190
WP29	195
WP30	95, 188
WP33	188
WP39	194
WP48	85, 189
WP49	192
WP59	193
WP60	193
WP65	193
WP67	192
WP68	192
WP69	195
WP69-...-G	195
WP71	193
WP89	193
WP92	194
WP93	194
WP99	194
WR29	142, 194
WU06	196
WU07	196





Z

ZS01	207
ZS10	207
ZS90	207









Aksesoria ozdobne meblowe / Furniture decorative accessories / Zierelemente / Лицевая мебельная фурнитура / Accesorios decorativos para muebles / Accessoires décoratifs pour meubles

Parametry / Dimensions / Parametern / Параметры / Parámetros / Paramètres









Wszystkie wymiary na rysunkach technicznych podane są w milimetrach / All dimensions on the technical drawings are in millimetres / Alle Abmessungen in den technischen Zeichnungen werden in mm angegeben. / Все размеры на чертежах указаны в миллиметрах / Todas las medidas de los dibujos técnicos están especificadas en milímetros / Toutes les dimensions indiquées sur les dessins techniques sont en millimètres

	Rozstaw / Cc distance / Bohrabstand / Расстояние / Distancia / Entraxe
	Długość modelu / Total length / Länge / Длина модели / Longitud de modelo / Longueur du modèle
	Wysokość / Height / Höhe / Высота / Altura / Hauteur
	Średnica preta/profilu / Diameter of bar/profile / Stab- und Profil-Durchmesser / Диаметр ручки/профиля / Diámetro de tubo/perfil / Diamètre de la barre/du profilé

Kolor / Colour / Farbe / Цвет / Color / Couleur

	Kolor pokrycia galwanicznego / Galvanikbeschichtung / Farbe der galvanischen Beschichtung / Цвет гальванического покрытия / Color del revestimiento electrolítico / Couleur du revêtement galvanisé
	Kolor stopki / Feet colour / Oberfläche des Fußes / Цвет ножки / Color del pie / Couleur du pied
	Kolor części chwytowej / Colour of bar / Oberfläche des Griffteiles / Цвет ручки / Color del asa / Couleur de la partie préhensile
	Kolor łączenia / Connect colour / Oberfläche des Verbindungselements / Цвет соединения / Color del acortamiento / Couleur du raccord
	Kolor drewna / Wood colour / Farbe der Holzteile / Цвет джева / Color de madera / Couleur du bois
	Kolor porcelany / Porcelain colour / Farbe der Porzellantteile / Цвет фарфора / Color de la porcelana / Couleur de la porcelaine
	Kolor tworzywa / Plastic colour / Farbe der Kunststoffe / Цвет пластмассы / Color de plástico / Couleur du plastique
	Kolor szkła / Glass colour / Farbe der Glaselemente / Цвет стекла / Color de vidrio / Couleur du verre

Inne / Other / Sonstige / Другие / Otros / Autres

	Rozstaw 1 / Cc 1 / Bohrabstand 1 / Расстояние 1 / Distancia 1 / Écartement 1
	Rozstaw 2 / Cc 2 / Bohrabstand 2 / Расстояние 2 / Distancia 2 / Écartement 2
	Kolor 1 / Colour 1 / Farbe 1 / Цвет 1 / Color 1 / Couleur 1
	Kolor 2 / Colour 2 / Farbe 2 / Цвет 2 / Color 2 / Couleur 2
	Inne / Other / Sonstige / Другие / Otros / Autres
	Wariant wykończenia / Other coatings / Variante der Ausführung / Вариант отделки / Versión de acabado / Variante de finition
	Prawa/lewa / Right/left / Rechts/links / Правая/левая / Derecha/izquierda / Droit/gauche
	Wielokrotność pakowania / Packing standard per box / Verpackungseinheit / Количество в упаковке / Número de unidades por envase / Conditionnement

Identyfikacja symbolu (przykład) / Codes (an example) / Die Symbole (Beispiel) / Идентификация идентификации (пример) / Descripción del símbolo (ejemplo) / Explicación de símbolo (ejemplo)

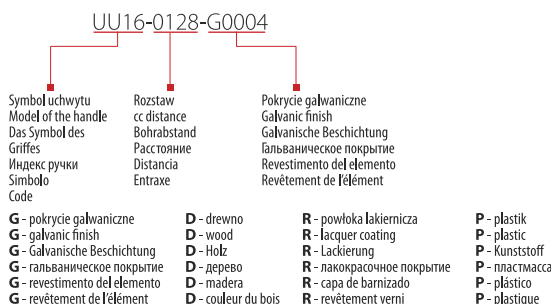

Kolory uchwytów aluminiowych / Aluminium handles colours / Aluminium Oberflächen / Цвета алюминиевых ручек / colores de los tiradores de aluminio / couleurs des poignées en aluminium



- AEC00 _____ Naturalne aluminium / Natural aluminium / Natural Aluminium eloxiert / Натуральный алюминий / Aluminio natural / Aluminium naturel
 AOC34 _____ Ciemny brązowy matowy / Mat dark brown / Dunkel braun matt / Темный махагонь матовый / Marrón oscuro mate / Brun foncé mat
 AOB34 _____ Ciemny brązowy połysk / Shiny dark brown / Dunkel braun glänzend / Темный махагонь блестящий / Marrón oscuro brillante / Brun foncé brillant
 AOC35 _____ Czarny matowy / Black matt / Schwarz matt / Черный матовый / Negro mate / Noir mat
 AOB35 _____ Czarny połysk / Black glossy / Schwarz glänzend / Черный блестящий / Negro brillante / Noir brillant
 APC35 _____ Czarny matowy (anoda) z przetarciami / Black matt with silver edges (anodized) / Schwarz matt (Anode) mit Abried / Черный матовый (анодированный) с сошлифованными ребрами / Negro mate (anodizado) pulido / Noir mat (anode) effacé par endroits
 APB35 _____ Czarny połysk (anoda) z przetarciami / Shiny black with silver edges (anodized) / Schwarz glänzend (Anode) mit Abried / Черный блестящий (анодированный) с сошлифованными ребрами / Negro brillante (anodizado) pulido / Noir brillant (anode) effacé par endroits
 AEC00 _____ Aluminium elektropolowane / Silver anodized / Aluminium poliert / Алюминий электрополирование / Aluminio electropulido / Aluminium électropoli
 AGC00 _____ Aluminium grubo szcztokowane / Thick brushed aluminium / Aluminium grob gebürstet / Алюминий крупно крацованный / Aluminio cepillado grueso / Aluminium brossé épais
 G0004 _____ Chrom / Chrome / Chrom glänzend / Хром / Cromo / Chrome
 G0007 _____ Nikiel szcztokowany / Brushed nickel / Nickel gebürstet (Edelstahloptik) / Крацованный никель / Niquel cepillado / Nickel brossé

* kolor niestandardowy / non-standard colour / Sonderbeschichtung / Цвет нестандартный / Color atípico / couleur non standard

Wzory na wyrobach porcelanowych / Porcelain patterns / Verfügbare Muster / Образцы рисунка на фарфоре / Muestrario de diseños en los elementos de porcelana / Motifs pour éléments en porcelaine

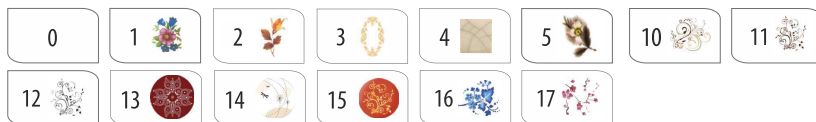

Kolor porcelany / Porcelain colour / Farbe der Porzellanteile / Цвет фарфора / Color porcelana / Couleur de la porcelaine



- Identyfikacja symbolu
 How to read the symbols
 Beschreibung der Artikelnummer
 Идентификация индекса
 Descripción del símbolo
 Identification du symbole

- 1 - Symbol / Type / Name / Символ / Símbolo / Symbole
 2 - Rozstaw / Cc distance / Bohrabstand / Расстояние / Distancia / Écartement
 3 - Pokrycie elementu / Finishing colour / Beschichtung / Гальваническое покрытие ZnAl / Revestimiento del elemento / Revêtement de l'élément
 4 - Kolor porcelany / Porcelain colour / Porzellanfarbe / Цвет фарфор / Color porcelana / Couleur de la porcelaine
 5 - Nr wzoru / Pattern type / Muster / Номер образца рисунка / Código de muestra / N° du modèle

Wzornik kolorów drewna / Wood colours / Farbe der Holzelemente / Шаблон цветов дерева / Muestrario de colores de madera / Nuancier couleurs bois

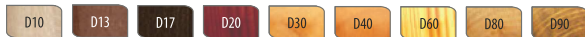

- D10 _____ Buk / Beech / Buche / Бук / Haya / Hêtre
 D13 _____ Grusza / Pear / Birne / Груша / Peral / Poirier
 D17 _____ Venge / Venge / Venge / Венге / Venge / Wenge
 D20 _____ Махоґ / Mahogany / Mahogany / Махагонь / Саоба / Асајоу
 D30 _____ Олха / Alder / Erle / Ольха / Aliso / Aulne
 D40 _____ Buk bawaria / Bavarian beech / Bayerische Buche / Бук баварский / Haya de Baviera / Hêtre de Bavière
 D60 _____ Sosna / Pine / Pinie / Сосна / Pino / Pin
 D80 _____ Дąб / Oak / Eiche / Дуб / Roble / Chêne
 D90 _____ Дąб rustykalny / Rustical oak / Eiche rustikal / Рустикальный дуб / Roble rústico / Chêne rustique

Tworzywo foliowane / Folied plastic / Kunststoff foliert / Пластмасса / Plástico laminado / Plastique pelliculé



- PF10 _____ Buk / Beech / Buche / Бук / Haya / Hêtre
 PF14 _____ Orzech / Walnut / Opex / Nuss / Noyer / Nogal
 PF30 _____ Олха / Alder / Erle / Ольха / Aliso / Aulne

Tworzywo / Plastic / Farbe der Kunststoffteile / Пластмасса / Plástico / Plastique



- P20 _____ Brązowy / Brown / Braun / Махагонь / Marrón / Marron
 P30 _____ Czarny / Black / Schwarz / Олха / Negro / Noir
 P40 _____ Biały / White / Weiß / Белый / Blanco / Blanc

■ **Wzornik powłok lakierniczych / Samples of lacquer coatings / Lackierte Oberflächen / Шаблон лакокрасочных покрытий / Muestrario de capas de barniz / Nuancier revêtements vernis**

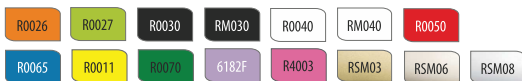

R0020	_____	Brazowy / Brown / Braun / Махагонь / Marrón / Marron
R0026	_____	Pomarańczowy / Orange / Orange / Оранжевый / Naranja / Orange
R0027	_____	Jaskrawy zielony / Bright green / Hellgrün / Ярко-зеленый / Verde vivo / Vert criard
R0030	_____	Czarny połysk / Black glossy / Schwarz glänzend / Черный блестящий / Negro brillante / Noir brillant
RM030	_____	Czarny matowy / Black matt / Schwarz matt / Черный матовый / Negro mate / Noir mat
R0040	_____	Biały połysk / White glossy / Weiß glänzend / Белый блестящий / Blanco brillante / Blanc brillant
RM040	_____	Biały matowy / White matt / Weiß matt / Белый матовый / Blanco mate / Blanc mat
R0050	_____	Czerwony / Red / Rot / Красный / Rojo / Rouge
R0065	_____	Granatowy / Navy blue / Dunkelblau / Темно синий / Azul marino / Bleu marine
R0011	_____	Żółty / Yellow / Gelb / Желтый / Amarillo / Jaune
R0070	_____	Zielony / Green / Grün / Зеленый / Verde / Vert
6182F	_____	Jasny różowy / Light pink / Hellrosa / Ярко-розовый / Rosa daro / Rose clair
R4003	_____	Różowy / Pink / Rosa / Розовый / Rosa / Rose
RSM03	_____	Mosiądz satynowy / Satin brass / Messing satiniert / Сатиновая латунь / Latón satinado / Laiton satiné
RSM06	_____	Nikiel satynowy / Satin nickel / Nickel satiniert (matt) / Сатиновый никель / Niquel / Satinado / Nickel satiné
RSM08	_____	Chrom satynowy / Satin chrome / Chrom satiniert (matt) / Сатиновый хром / Cromo satinado / Chrome satiné

■ **Dostępne kolory w kolekcji CAMELEON / Cameleon collection - available colours / Kollektion Chamäleon verfügbare Farben / Доступные цвета в коллекции CAMELEON / Los colores disponibles en la colección CAMELEON / Les couleurs accessibles dans la collection CAMELEON**



Na życzenie Klienta możliwe jest przygotowanie indywidualnego koloru wkładki tworzywowej. Minimalna ilość zamówienia to 500 sztuk.
Other RAL colours of plastic part on request. Minimum order quantity 500 pcs.
Individuelle Farbe des Kunststoffesatzes ist auf Kundenwunsch möglich. Mindestbestellmenge 500 Stück.
По желанию клиента возможно изготовление пластмассовой вкладки в индивидуальном цвете. Минимальное количество - 500 шт
Posibilidad de otros colores en la plástica del tirador: bajo pedido - 500 piezas.
Il y a la possibilité d'avoir d'autres couleurs de la partie matière de la poignée - sur commande individuelle - 500 pièces.

Dostępne kolory w kolekcji HANTLE / HANTLE collection - available colours / Kollektion HANTLE: verfügbare Farben
Доступные цвета в коллекции HANTLE / Los colores disponibles en la colección HANTLE / Les couleurs accessibles dans la collection HANTLE



E30	_____	Czarna emalia / Black enamel / Emailen schwarz / Черная эмаль / Esmalte negro / Émail noir
E40	_____	Biała emalia / White enamel / Emailen weiß / Белая эмаль / Esmalte blanco / Émail blanc
E422	_____	Kość słoniowa / Ivory / Emailen - ivory / Эмаль - цвет слоновой кости / marfil / Ivoire
E50	_____	Czerwona emalia / Red enamel / Emailen rot / Красная эмаль / Esmalte rojo / Émail rouge

■ **Wzornik pokryć galwanicznych / Samples of galvanic coatings / Galvanische Oberflächen / Шаблон гальванических покрытий / muestrario de colores de revestimientos electrolíticos / nuancier des revêtements galvaniques**



- G0001 (GC001) — Czarny nikiel na podkladzie miedzi / Black nickel on copper basis / Kupfer schwarz vernickelt / Черный никель на основе меди / Niquel negro sobre base de cobre / Niquel noir sur base cuivre
- G0002 (GC002) — Czarny nikiel na podkladzie mosiądzu / Black nickel on brass basis / Messing schwarz vernickelt / Черный никель на основе латуни / Niquel negro sobre base de latón / Niquel noir sur base laiton
- G0003 — Mosiądz / Brass / Messing / Латунь / Latón / Laiton
- G0003 — Mosiądz satynowy / Satin brass / Messing satiniert / Сатиновая латунь / Latón satinado / Laiton satiné
- G0004 — Chrom / Chrome / Chrom glänzend / Хром / Cromo / Chrome
- G0005 — Patyna na mosiądzu / Patinated brass / Messing patiniert / Патина на латуни / Latón patinado / Patine sur laiton
- G0006 — Nikiel satynowy / Satin nickel / Nickel satiniert (matt) / Сатиновый никель / Niquel satinado / Nickel satiné
- G0007 — Nikiel szcztokowany / Brushed nickel / Nickel gebürstet (Edelstahloptik) / Крацованный никель / Niquel cepillado / Nickel brossé
- G0008 — Chrom satynowy / Satin chrome / Chrom satiniert (matt) / Сатиновый хром / Cromo satinado / Chrome satiné
- G0009 — Czarny nikiel polerowany / Polished black nickel / Nickel schwarz poliert / Черный полированный никель / Niquel negro pulido / Nickel noir poli
- GA011 — Nikiel patynowany / Patinated nickel / Nickel patiniert / Патинированный никель / Niquel patinado / Nickel patiné
- GNE03 — Mosiądz szcztokowany / Brushed brass / Messing gebürstet / Крацованная латунь / Latón cepillado / Laiton brossé
- G0035 — Antyczny mosiądz patynowany antique brass patinated / Antikmessing patiniert / Античная патинированная латунь / Latón antiguo patinado / L'antique patine sur laiton
- G0031 — Efekt „starego srebra” / Old silver effect / alt Silber – Effekt / Эффект „старого серебра” / Latón patinado antiguo / Cuivre patiné antique
- VG00P — VULCAN GRAY - czarny chrom / VULCAN GRAY / Schwarzchrom / Черный хром / Cromo negro / Chrome noir
- G0018 — Miedź polysk / Polished copper / Kupfer glänzend / Янцевая медь / Cuivre brillant / Cobre brillante
- GE018 — Miedź szcztokowana / Brushed copper / Kupfer gebürstet / Крацованная медь / Cuivre brossé / Cobre cepillado
- GPM25 — Półmatowa patyna na miedzi / Semi matt patinated copper / Patina halbmatt auf Kupfer / Патинированная полуматовая медь / Mate semi patinado cobre / Patine semi-matte sur cuivre
- G0017 — Srebro / silver / Silber / Серебро / Plata / Argent
- GRM01 — Czarny nikiel na podkladzie miedzi szcztokowany / Brushed black nickel on copper base / Schwarznickel unterkupfert, gebürstet / Черный крацованный никель на основе меди / Negro cepillado sobre base de cobre / Nickel noir sur base de cuivre brossé
- GRA11 — Nikiel patynowany szcztokowany / Brushed patinated nickel / Nickel patiniert, gebürstet / Патинированный и крацованный никель / Niquel patinado cepillado / Nickelpatiné brossé
- GR005 — Patyna na mosiądzu szcztokowana / Patin on brushed brass / Messing patiniert, gebürstet / Патина на латуни крацованная / Patina cepillada sobre latón / Patine brossée sur laiton
- GJK05 — Patyna na mosiądzu lakierowanym / Patin on lacquered brass / Messing patiniert, lackiert / Патина на лакированной латуни / Patina sobre latón barnizado / Patine vernie sur laiton
- GAE02 — Staroangielski / Antique english / Altenglisch / Староанглийский / Inglés antiguo / Anglais-antique
- G00AB (GAB02) — Mosiądz antyczny / Antique brass / Antikmessing / Античная латунь / Latón antiguo / Laiton antique
- GME02 — Mosiądz antyczny matowy / Antique brass mat / Antikmessing matt / Матовая античная латунь / Latón antiguo mate / Laiton antique mat
- GM011 — Grafit / Graphite / Grafit / Графит / Grafite / Graphite
- GN005 — Patyna na mosiądzu II / Messing patiniert II / Messing patiniert II / Патина на латуни II / Latón patinado II / Patine sur laiton II
- AOC00 — Naturalne aluminium / Natural aluminium / Natural Aluminium eloxiert / Натуральный алюминий / Aluminio natural / Aluminium naturel

PL : Jest to materiał reklamowy zawierający informacje o produktach oferowanych przez Gamet S.A., który nie stanowi oferty w rozumieniu art. 66 kodeksu cywilnego. Gamet S.A. zastrzega prawo do wycofania niektórych produktów znajdujących się w jego ofercie. Gamet S.A. zastrzega, że na wybranych rynkach, dostępność oferowanych produktów jest ograniczona. W stosunku do niniejszego katalogu zastrzegamy sobie prawa autorskie. Bez naszego pisemnego pozwolenia zabronione jest kopiowanie katalogu w dowolnej formie zarówno w całości jak i w części. Zastrzega się możliwość wprowadzenia zmian technicznych. Nie przejmujemy odpowiedzialności za błędy w druku ani pomyłki. Kolory drukowane nie oddają w pełni realnych kolorów wyrobów. Wyroby należy stosować z przeznaczeniem w oparciu o normy DIN i PN. Produkty oznaczone tym symbolem (*) ze względu na niestandardowe wykonanie, dostępne są w ofercie po uprzednim szczegółowym uzgodnieniu i potwierdzeniu przez Przedstawiciela handlowego Gamet S.A., warunków realizacji zamówienia dotyczących m.in.: terminu wykonania, cen, aspektów logistycznych dostaw, jak i ilości. Zdjęcia aranżowane uchwyty wykonane dzięki uprzejmości Salonu BRW S.A., VIVA MEBEL, STOLGRO, STOLKAR.

EN : This is the advertising material containing information about the products offered by Gamet SA, which does not constitute an offer within the meaning of par. 66 of the Civil Code. Gamet SA We reserve the right to withdraw certain products included in the offer. Gamet SA It stipulates that in selected markets, the availability of the products offered is limited. In relation to this catalog, we reserve the copyright. Without our written permission is prohibited to copy the catalog in any form either in whole or in part. We reserve the right to make technical changes. No liability for printing errors or mistakes. The colors printed does not fully reflect the real color of the products. Products must be used for the purpose on the basis of DIN and PN. Products marked with this symbol (*) due to the custom finishes are available in the offer after detailed consultation and confirmation by the Representative of trade Gamet SA, contract performance conditions concerning, among others: the date of implementation, pricing, logistical aspects of supply and quantity, Staged pictures of showrooms BRW S.A., VIVA MEBEL, STOLGRO, STOLKAR.

DE : Das ist ein Werbematerial, das die Information über die von GAMET S.A. angebotenen Produkte enthält und nicht als Angebot im Rahmen des Art. 66 des Zivilgesetzbuchs zu verstehen ist. GAMET S.A. behält sich vor, manche Produkte, die es in diesem Angebot gibt, zurückzunehmen. GAMET S.A. behält sich vor, dass auf den ausgewählten Märkten die Zugänglichkeit der angebotenen Produkte begrenzt ist. Für diesen Katalog behalten wir uns alle Rechte aus dem Urheberrecht vor. Ohne unsere schriftliche Genehmigung ist es nicht erlaubt, den Katalog oder Teile daraus in irgendeiner Form zu kopieren. Technische Änderungen vorbehalten. Wir übernehmen keine Verantwortung für Druckfehler oder Irrtümer. Farbabweichung vorbehalten. Die Produkte sollen laut DIN und PN angewandt werden. Die Bestellung der mit (*) gekennzeichneten Produkte gilt wegen ihrer unstandardsmäßigen Ausführung erst nach einer Bestätigung über Details seitens der Vertriebsvertreter von GAMET S.A. (u. a. Liefertermin, Preis, Menge, Lieferbedingungen) als angenommen. Arrangierte Fotos mit Dank an BRW S.A., VIVA MEBEL, STOLGRO, STOLKAR gemacht.

RU : Это рекламный материал, содержащий информацию о продуктах компании Gamet S.A., который не является предложением согласно толкованию статьи № 66 гражданского кодекса. Gamet S.A. оставляет за собой право вывешать часть продукции из своего ассортимента. Gamet S.A. оставляет за собой право ограничения своего предложения на некоторых рынках. На данный каталог распространяется авторское право. Без нашего письменного разрешения запрещено копирование каталога в любой форме, как целого, так и в частях. Договора возможность введения технических изменений. Не принимаем на себя ответственность за возможные ошибки в тексте и печати. Отпечатанные цвета могут не соответствовать в точности реальным цветам продуктов. Продукты следует использовать по назначению, согласно нормам DIN и PN. Продукты, обозначенные символом (*) из-за нестандартного покрытия доступны только после детального обсуждения и подтверждения. Условиями Представителем Gamet S.A. условий реализации заказа на них, а именно: сроков изготовления, цен, некоторых аспектов логистики поставок и количества. Фотографии композиции мебельных ручек сделаны благодаря фирмам BRW S.A., VIVA MEBEL, STOLGRO, STOLKAR.

ES : GAMET S.A. se reserva los derechos de autor sobre el contenido del presente catalogo. Queda expresamente prohibida la reproducción total o parcial de este catalogo por cualquier medio sin nuestro consentimiento previo por escrito. Reservado el derecho de modificaciones técnicas. GAMET S.A. no asume responsabilidad por errores de impresión o fallos. Los colores impresos no reproducen fielmente los colores reales de los productos. Los productos deben ser utilizados conforme a su uso indicado en las normas Din y las normas polacas PL. Los productos marcados con un asterisco (*) debido a su acabado atípico estarán disponibles una vez que el Representante Comercial de GAMET S.A. haya acordado confirmado las condiciones de realización del pedido relativas, entre otros, a: plazo realización, precios, aspectos logísticos de suministros y cantidades. Las fotos de las composiciones de tiradores han sido realizadas gracias a la cortesía de las empresas BRW S.A., VIVA MEBEL, STOLGRO, STOLKAR.

FR : Nous disposons des droits d'auteur pour le présent catalogue. Il est interdit de copier une partie ou tout le catalogue sans une autorisation écrite préalable de notre part. Nous nous réservons le droit d'introduire des modifications techniques. Nous ne sommes pas responsable d'éventuelles fautes d'impression ou d'erreurs. Couleurs imprimées ne rendent pas fidèlement les couleurs réelles des produits. Les produits doivent être utilisés conformément à leur destination, en accord avec les normes. Les produits indiqués par (*), à cause de leur finition non standard, ne deviennent disponibles qu'après l'accord et après la confirmation par le représentant commercial de GAMET S.A. des conditions de réalisation de la commande concernant, entre autres: délai de fabrication, prix, aspects logistiques des livraisons et quantités. Les photos des compositions de poignées de meuble ont été effectuées grâce à la courtoisie des entreprises commerciales BRW S.A., VIVA MEBEL, STOLGRO, STOLKAR.

GAMET S.A.

ul. Kociewska 22

87-100 Toruń

Polska

Biuro Obsługi Klienta / Customer Service Office /
Kundenservice / Бюро обслуживания клиентов

PL - +48 56 646 22 00

EN - +48 56 611 01 80

RU - +48 56 611 01 75

DE - +48 56 611 01 57

fax +48 56 611 00 01

gamet@gamet.eu

Gamet GmbH

Ziegelei-Töpker-Straße 10

33154 Salzkotten

Deutschland

Kundenservice

tel. +49 525 89 351 095

fax +49 525 89 748 046

de@gamet.eu



www.gamet.eu

